

# PILOT'S OPERATING HANDBOOK

  
Cessna. 1977

## 150 Commuter

CESSNA MODEL 150M



# PERFORMANCE - SPECIFICATIONS

**SPEED:**

Maximum at Sea Level . . . . .	109 KNOTS
Cruise, 75% Power at 7000 Ft . . . . .	106 KNOTS

**CRUISE:** Recommended Lean Mixture with fuel allowance for engine start, taxi, takeoff, climb and 45 minutes reserve at 45% power.

75% Power at 7000 Ft . . . . .	Range	340 NM
22.5 Gallons Usable Fuel . . . . .	Time	3.3 HRS
75% Power at 7000 Ft . . . . .	Range	580 NM
35 Gallons Usable Fuel . . . . .	Time	5.5 HRS
Maximum Range at 10,000 Ft . . . . .	Range	420 NM
22.5 Gallons Usable Fuel . . . . .	Time	4.9 HRS
Maximum Range at 10,000 Ft . . . . .	Range	735 NM
35 Gallons Usable Fuel . . . . .	Time	8.5 HRS

<b>RATE OF CLIMB AT SEA LEVEL</b> . . . . .	670 FPM
<b>SERVICE CEILING</b> . . . . .	14,000 FT

**TAKEOFF PERFORMANCE:**

Ground Roll . . . . .	735 FT
Total Distance Over 50-Ft Obstacle . . . . .	1385 FT

**LANDING PERFORMANCE:**

Ground Roll . . . . .	445 FT
Total Distance Over 50-Ft Obstacle . . . . .	1075 FT

**STALL SPEED (CAS):**

Flaps Up, Power Off . . . . .	48 KNOTS
Flaps Down, Power Off . . . . .	42 KNOTS

<b>MAXIMUM WEIGHT</b> . . . . .	1600 LBS
---------------------------------	----------

**STANDARD EMPTY WEIGHT:**

Commuter . . . . .	1111 LBS
Commuter II . . . . .	1129 LBS

**MAXIMUM USEFUL LOAD:**

Commuter . . . . .	489 LBS
Commuter II . . . . .	471 LBS

<b>BAGGAGE ALLOWANCE</b> . . . . .	120 LBS
------------------------------------	---------

<b>WING LOADING:</b> Pounds/Sq Ft . . . . .	10.0
---	------

<b>POWER LOADING:</b> Pounds/HP . . . . .	16.0
---	------

**FUEL CAPACITY: Total**

Standard Tanks . . . . .	26 GAL.
Long; Range Tanks . . . . .	38 GAL.

<b>OIL CAPACITY</b> . . . . .	6 QTS
-------------------------------	-------

<b>ENGINE:</b> Teledyne Continental . . . . .	O-200-A
100 BHP at 2750 RPM . . . . .	

<b>PROPELLER:</b> Fixed Pitch, Diameter . . . . .	69 IN.
---	--------

# PILOT'S OPERATING HANDBOOK

**Cessna**

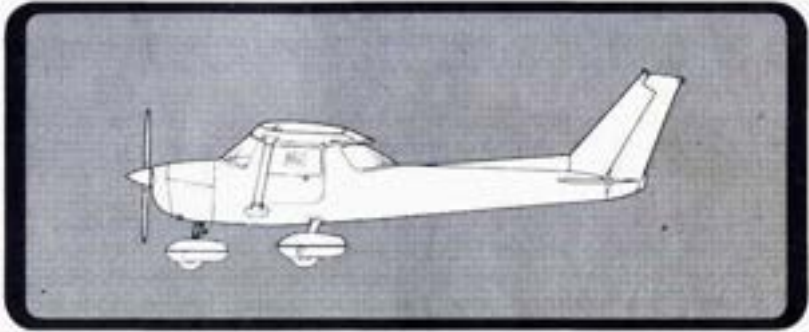

## **150 COMMUTER**

**1977 MODEL 150M**

Serial No. \_\_\_\_\_

Registration No. \_\_\_\_\_

**THIS HANDBOOK INCLUDES THE MATERIAL  
REQUIRED TO BE FURNISHED TO THE PILOT  
BY CAR PART 3**

**CESSNA AIRCRAFT COMPANY  
WICHITA, KANSAS, USA**

# CONGRATULATIONS....

Welcome to the ranks of Cessna owners! Your Cessna has been designed and constructed to give you the most in performance, economy, and comfort. It is our desire that you will find flying it, either for business or pleasure, a pleasant and profitable experience.

This Pilot's Operating Handbook has been prepared as a guide to help you get the most pleasure and utility from your airplane. It contains information about your Cessna's equipment, operating procedures, and performance; and suggestions for its servicing and care. We urge you to read it from cover to cover, and to refer to it frequently.

Our interest in your flying pleasure has not ceased with your purchase of a Cessna. Worldwide, the Cessna Dealer Organization backed by the Cessna Customer Services Department stands ready to serve you. The following services are offered by most Cessna Dealers:

- THE CESSNA WARRANTY, which provides coverage for parts and labor, is available at Cessna Dealers worldwide. Specific benefits and provisions of warranty, plus other important benefits for you, are contained in your Customer Care Program book, supplied with your airplane. Warranty service is available to you at authorized Cessna Dealers throughout the world upon presentation of your Customer Care Card which establishes your eligibility under the warranty.
- FACTORY TRAINED PERSONNEL to provide you with courteous expert service.
- FACTORY APPROVED SERVICE EQUIPMENT to provide you efficient and accurate workmanship.
- A STOCK OF GENUINE CESSNA SERVICE PARTS on hand when you need them.
- THE LATEST AUTHORITATIVE INFORMATION FOR SERVICING CESSNA AIRPLANES, since Cessna Dealers have all of the Service Manuals and Parts Catalogs, kept current by Service Letters and Service News Letters, published by Cessna Aircraft Company.

We urge all Cessna owners to use the Cessna Dealer Organization to the fullest.

A current Cessna Dealer Directory accompanies your new airplane. The Directory is revised frequently, and a current copy can be obtained from your Cessna Dealer. Make your Directory one of your cross-country flight planning aids; a warm welcome awaits you at every Cessna Dealer.

# TABLE OF CONTENTS

	SECTION
GENERAL . . . . .	.1
LIMITATIONS. . . . .	.2
EMERGENCY PROCEDURES. . . . .	.3
NORMAL PROCEDURES. . . . .	.4
PERFORMANCE. . . . .	.5
WEIGHT & BALANCE/ EQUIPMENT LIST. . . . .	.6
AIRPLANE & SYSTEMS DESCRIPTIONS. . . . .	.7
AIRPLANE HANDLING, SERVICE & MAINTENANCE. . . . .	.8
SUPPLEMENTS (Optional Systems Description & Operating Procedures). . . . .	.9

This handbook will be kept current by Service Letters published by Cessna Aircraft Company. These are distributed to Cessna Dealers and to those who subscribe through the Owner Follow-Up System. If you are not receiving subscription service, you will want to keep in touch with your Cessna Dealer for information concerning the change status of the handbook. Subsequent changes will be made in the form of stickers. These should be examined and attached to the appropriate page in the handbook immediately after receipt; the handbook should not be used for operational purposes until it has been updated to a current status.

# SECTION 1 GENERAL

## TABLE OF CONTENTS

	Page
Three View . . . . .	1-2
Introduction . . . . .	1-3
Descriptive Data . . . . .	1-3
Engine . . . . .	1-3
Propeller. . . . .	1-3
Fuel . . . . .	1-3
Oil . . . . .	1-4
Maximum Certificated Weights. . . . .	1-5
Standard Airplane Weights. . . . .	1-5
Cabin and Entry Dimensions. . . . .	1-5
Baggage Space Dimensions. . . . .	1-5
Specific Loadings. . . . .	1-5
Symbols, Abbreviations and Terminology. . . . .	1-5
General Airspeed Terminology and Symbols. . . . .	1-5
Meteorological Terminology. . . . .	1-6
Engine Power Terminology. . . . .	1-7
Airplane Performance and Flight Planning Terminology . . . . .	1-7
Weight and Balance Terminology. . . . .	1-7

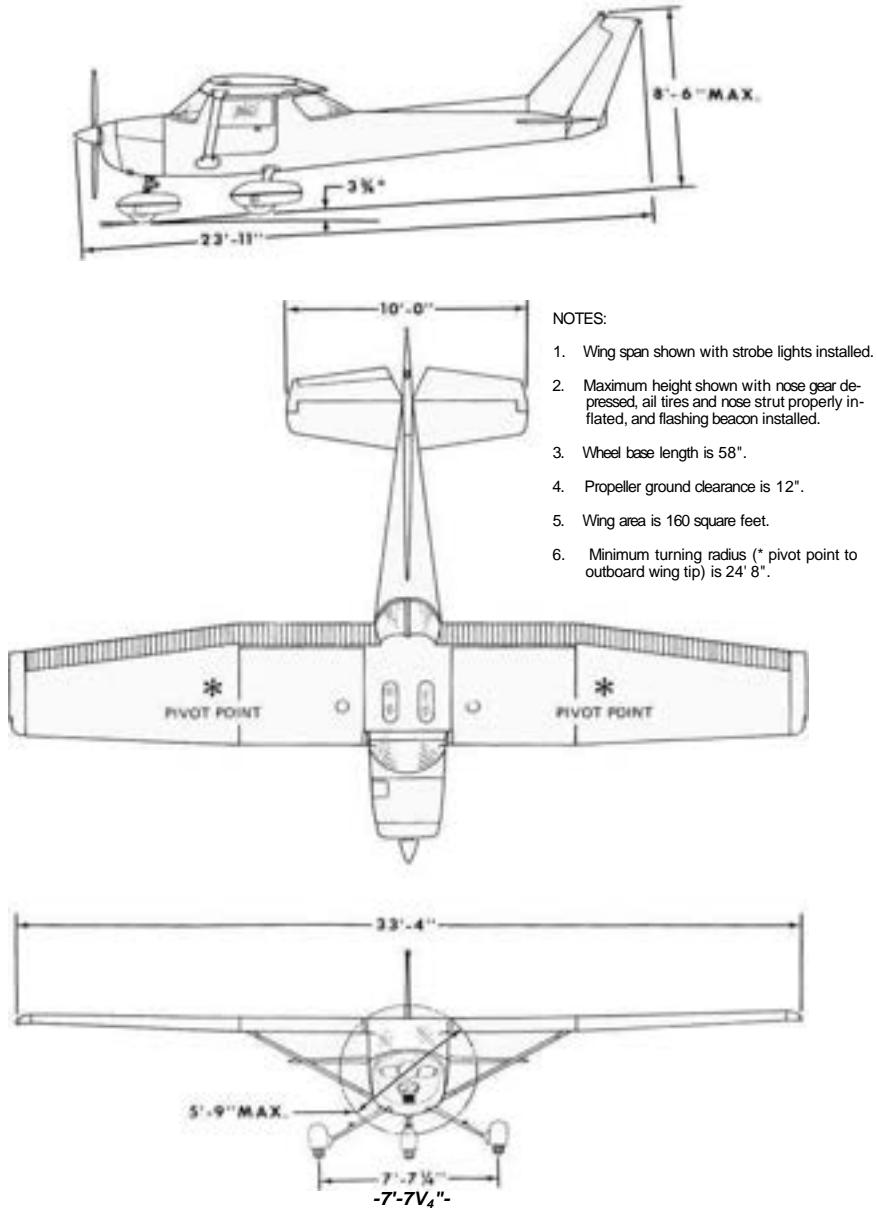

Figure 1-1. Three View

## INTRODUCTION

This handbook contains 9 sections, and includes the material required to be furnished to the pilot by CAR Part 3. It also contains supplemental data supplied by Cessna Aircraft Company.

Section 1 provides basic data and information of general interest. It also contains definitions or explanations of symbols, abbreviations, and terminology commonly used.

## DESCRIPTIVE DATA

### ENGINE

Number of Engines: 1.

Engine Manufacturer: Teledyne Continental.

Engine Model Number: O-200-A.

Engine Type: Normally-aspirated, direct-drive, air-cooled, horizontally-opposed, carburetor equipped, four-cylinder engine with 201 cu. in. displacement.

Horsepower Rating and Engine Speed: 100 rated BHP at 2750 RPM.

### PROPELLER

Propeller Manufacturer: McCauley Accessory Division.

Propeller Model Number: 1A102/OCM6948.

Number of Blades: 2.

Propeller Diameter, Maximum: 69 inches.

Minimum: 67.5 inches.

Propeller Type: Fixed pitch.

### FUEL

Approved Fuel Grades (and Colors):

80 (Formerly 80/87) Grade Aviation Fuel (Red).

100LL Grade Aviation Fuel (Blue).

100 (Formerly 100/130) Grade Aviation Fuel (Green).



Fuel Capacity:

Standard Tanks:

Total Capacity: 26 gallons.

Total Capacity Each Tank: 13 gallons.

Total Usable: 22.5 gallons.

Long Range Tanks:

Total Capacity: 38 gallons.

Total Capacity Each Tank: 19 gallons.

Total Usable: 35 gallons.

NOTE

Due to cross-feeding between fuel tanks, the tanks should be re-topped after each refueling to assure maximum capacity.

**OIL**

Oil Grade (Specification):

MIL-L-6082 Aviation Grade Straight Mineral Oil: Use to replenish supply during first 25 hours and at the first 25-hour oil change. Continue to use until a total of 50 hours has accumulated or oil consumption has stabilized.

NOTE

The airplane was delivered from the factory with a corrosion preventive aircraft engine oil. This oil should be drained after the first 25 hours of operation.

Continental Motors Specification MHS-24A, Ashless Dispersant **Oil:**  
This oil must be used after first 50 hours or oil consumption has stabilized.

Recommended Viscosity For Temperature Range:

SAE 40 above 4°C (40°F).

SAE 10W30 or SAE 20 below 4°C (40°F).

NOTE

Multi-viscosity oil with a range of SAE 10W30 is recommended for improved starting in cold weather.

**Oil Capacity:**

Sump: 6 Quarts.

Total: 7 Quarts (if oil filter installed).

## MAXIMUM CERTIFICATED WEIGHTS

Takeoff: 1600 lbs.

Landing: 1600 lbs.

Weight in Baggage Compartment:

Baggage Area 1 (or passenger on child's seat)-Station 50 to 76:  
120 lbs. See note below.

Baggage Area 2 - Station 76 to 94: 40 lbs. See note below.

### NOTE

The maximum combined weight capacity for baggage areas 1 and 2 is 120 lbs.

## STANDARD AIRPLANE WEIGHTS

Standard Empty Weight, Commuter: 1111 lbs.

Commuter II: 1129 lbs.

Maximum Useful Load, Commuter: 489 lbs.

Commuter II: 471 lbs.

## CABIN AND ENTRY DIMENSIONS

Detailed dimensions of the cabin interior and entry door openings are illustrated in Section 6.

## BAGGAGE SPACE DIMENSIONS

Dimensions of the baggage area are illustrated in detail in Section 6.

## SPECIFIC LOADINGS

Wing Loading: 10.0 lbs./sq. ft.

Power Loading: 16.0 lbs./hp.

# SYMBOLS, ABBREVIATIONS AND TERMINOLOGY

## GENERAL AIRSPEED TERMINOLOGY AND SYMBOLS

KCAS      Knots Calibrated Airspeed is indicated airspeed corrected for position and instrument error and expressed in knots. Knots calibrated airspeed is equal to KTAS in standard atmosphere at sea level.

- KIAS      Knots Indicated Airspeed is the speed shown on the airspeed indicator and expressed in knots.
- KTAS      Knots True Airspeed is the airspeed expressed in knots relative to undisturbed air which is KCAS corrected for altitude and temperature.
- V.          Maneuvering Speed is the maximum speed at which you may use abrupt control travel.
- V<sub>FE</sub>        Maximum Flap Extended Speed is the highest speed permissible with flaps in a prescribed extended position.
- V<sub>NQ</sub>        Maximum Structural Cruising Speed is the speed that should not be exceeded except in smooth air, then only with caution.
- V<sub>NE</sub>        Never Exceed Speed is the speed limit that may not be exceeded at any time.
- V<sub>S</sub>          Stalling Speed or the minimum steady flight speed at which the airplane is controllable.
- V<sub>S</sub> °        Stalling Speed or the minimum steady flight speed at which the airplane is controllable in the landing configuration at the most forward center of gravity.
- V<sub>x</sub>          Best Angle-of-Climb Speed is the speed which results in the greatest gain of altitude in a given horizontal distance.
- V<sub>v</sub>          Best Rate-of-Climb Speed is the speed which results in the greatest gain in altitude in a given time.

## METEOROLOGICAL TERMINOLOGY

- OAT          Outside Air Temperature is the free air static temperature. It is expressed in either degrees Celsius (formerly Centigrade) or degrees Fahrenheit.
- Standard Temperature      Standard Temperature is 15°C at sea level pressure altitude and decreases by 2 °C for each 1000 feet of altitude.
- Pressure Altitude          Pressure Altitude is the altitude read from an altimeter when the altimeter's barometric scale has been set to 29.92 inches of mercury (1013 mb).

## ENGINE POWER TERMINOLOGY

BHP            Brake Horsepower is the power developed by the engine.

RPM        Revolutions Per Minute is engine speed.

Static        Static RPM is engine speed attained during a full-throttle engine runup when the airplane is on the ground and stationary.

## AIRPLANE PERFORMANCE AND FLIGHT PLANNING TERMINOLOGY

Demonstrated Crosswind Velocity        Demonstrated Crosswind Velocity is the velocity of the crosswind component for which adequate control of the airplane during takeoff and landing was actually demonstrated during certification tests. The value shown is not considered to be limiting.

Usable Fuel    Usable Fuel is the fuel available for flight planning.

Unusable Fuel    Unusable Fuel is the quantity of fuel that can not be safely used in flight.

GPH            Gallons Per Hour is the amount of fuel (in gallons) consumed per hour.

NMPG        Nautical Miles Per Gallon is the distance (in nautical miles) which can be expected per gallon of fuel consumed at a specific engine power setting and/or flight configuration.

g                g is acceleration due to gravity.

## WEIGHT AND BALANCE TERMINOLOGY

Reference Datum    Reference Datum is an imaginary vertical plane from which all horizontal distances are measured for balance purposes.

Station        Station is a location along the airplane fuselage given in terms of the distance from the reference datum.

Arm            Arm is the horizontal distance from the reference datum to the center of gravity (C.G. ) of an item.

Moment        Moment is the product of the weight of an item multiplied by its arm. (Moment divided by the constant 1000 is used in this handbook to simplify balance calculations by reducing the number of digits. )

Center of Gravity (C.G.)	<u>Center of Gravity</u> is the point at which an airplane, or equipment, would balance if suspended. Its distance from the reference datum is found by dividing the total moment by the total weight of the airplane.
C.G. Arm	<u>Center of Gravity Arm</u> is the arm obtained by adding the airplane's individual moments and dividing the sum by the total weight.
C.G. Limits	<u>Center of Gravity Limits</u> are the extreme center of gravity locations within which the airplane must be operated at a given weight.
Standard Empty Weight	<u>Standard Empty Weight</u> is the weight of a standard airplane, including unusable fuel, full operating fluids and full engine oil.
Basic Empty Weight	<u>Basic Empty Weight</u> is the standard empty weight plus the weight of optional equipment.
Useful Load	<u>Useful Load</u> is the difference between takeoff weight and the basic empty weight.
Gross (Loaded) Weight	<u>Gross (Loaded) Weight</u> is the loaded weight of the airplane.
Maximum Takeoff Weight	<u>Maximum Takeoff Weight</u> is the maximum weight approved for the start of the takeoff run.
Maximum Landing Weight	<u>Maximum Landing Weight</u> is the maximum weight approved for the landing touchdown.
Tare	<u>Tare</u> is the weight of chocks, blocks, stands, etc. used when weighing an airplane, and is included in the scale readings. Tare is deducted from the scale reading to obtain the actual (net) airplane weight.

# SECTION 2 LIMITATIONS

## TABLE OF CONTENTS

	Page
Introduction . . . . .	2-3
Airspeed Limitations . . . . .	2-3
Airspeed Indicator Markings . . . . .	2-4
Power Plant Limitations . . . . .	2-4
Power Plant Instrument Markings . . . . .	2-5
Weight Limits . . . . .	2-5
Center of Gravity Limits . . . . .	2-5
Maneuver Limits . . . . .	2-6
Flight Load Factor Limits . . . . .	2-6
Kinds of Operation Limits . . . . .	2-6
Fuel Limitations . . . . .	2-7
Placards . . . . .	2-8



## INTRODUCTION

Section 2 includes operating limitations, instrument markings, and basic placards necessary for the safe operation of the airplane, its engine, standard Systems and standard equipment. The limitations included in this section have been approved by the Federal Aviation Administration. When applicable, limitations associated with optional Systems or equipment are included in Section 9.

Your Cessna is certificated under FAA Type Certificate No. 3A19 as Cessna Model No. 150M.

## AIRSPEED LIMITATIONS

Airspeed limitations and their operational significance are shown in figure 2-1.

	SPEED	KCAS	KIAS	REMARKS
	Never Exceed Speed	141	141	Do not exceed this speed in any operation.
<b>V<sub>NO</sub></b>	Maximum Structural Cruising Speed	104	107	Do not exceed this speed except in smooth air, and then only with caution.
<b>V<sub>A</sub></b>	Maneuvering Speed: 1600 Pounds 1450 Pounds 1300 Pounds	95 90 85	97 93 88	Do not make full or abrupt control movements above this speed.
<b>V<sub>FE</sub></b>	Maximum Flap Extended Speed	89	85	Do not exceed this speed with flaps down.
	Maximum Window Open Speed	141	141	Do not exceed this speed with Windows open.

Figure 2-1. Airspeed Limitations



## AIRPEED INDICATOR MARKINGS

Airspeed indicator markings and their color code significance are shown in figure 2-2.

MARKING	KIAS VALUE OR RANGE	SIGNIFICANCE
White Arc	42-85	Full Flap Operating Range. Lower limit is maximum weight $V_{so}$ in landing configuration. Upper limit is maximum speed permissible with flaps extended.
Green Arc	47 - 107	Normal Operating Range. Lower limit is maximum weight $V_g$ at most forward C.G. with flaps retracted. Upper limit is maximum structural cruising speed.
Yellow Arc	107 - 141	Operations must be conducted with caution and only in smooth air.
Red Line	141	Maximum speed for all operations.

Figure 2-2. Airspeed Indicator Markings

## POWER PLANT LIMITATIONS

Engine Manufacturer: Teledyne Continental.

Engine Model Number: O-200-A

Engine Operating Limits for Takeoff and Continuous Operations:

Maximum Power: 100 BHP.

Maximum Engine Speed: 2750 RPM.

### NOTE

The static RPM range at full throttle (carburetor heat off and full rich mixture) is 2460 to 2560 RPM.

Maximum Oil Temperature: 116°C (240°F).

Oil Pressure, Minimum: 10 psi.

Maximum: 100 psi.

Propeller Manufacturer: McCauley Accessory Division.

Propeller Model Number: 1A102/OCM6948.

Propeller Diameter, Maximum: 69 inches.

Minimum: 67.5 inches.

## POWER PLANT INSTRUMENT MARKINGS

Power plant instrument markings and their color code significance are shown in figure 2-3.

INSTRUMENT	RED LINE	GREEN ARC	RED LINE
	MINIMUM LIMIT	NORMAL OPERATING	MAXIMUM LIMIT
Tachometer		2000 - 2750 RPM	2750 RPM
Oil Temperature		100° - 240°F	240° F
Oil Pressure	10 psi	30 - 60 psi	100 psi

Figure 2-3. Power Plant Instrument Markings

## WEIGHT LIMITS

Maximum Takeoff Weight: 1600 lbs.

Maximum Landing Weight: 1600 lbs.

Maximum Weight in Baggage Compartment:

Baggage Area 1 (or passenger on child's seat)-Station 50 to 76:  
120 lbs. See note below.

Baggage Area 2 -Station 76 to 94: 40 lbs. See note below.

### NOTE

The maximum combined weight capacity for baggage areas 1 and 2 is 120 lbs.

## CENTER OF GRAVITY LIMITS

Center of Gravity Range:

Forward: 31.5 inches aft of datum at 1280 lbs. or less, with  
straight line variation to 32.9 inches aft of datum at 1600 lbs.

Aft: 37.5 inches aft of datum at all weights.

Reference Datum: Front face of firewall.

## MANEUVER LIMITS

This airplane is certificated in the utility category and is designed for limited aerobatic flight. In the acquisition of various certificates such as commercial pilot, instrument pilot and flight instructor, certain maneuvers are required. All of these maneuvers are permitted in this airplane.

No aerobatic maneuvers are approved except those listed below:

<u>MANEUVER</u>	<u>MAXIMUM ENTRY SPEED*</u>
Chandelles . . . . .	95 knots
Lazy Eights . . . . .	95 knots
Steep Turns . . . . .	95 knots
Spins . . . . .	Use Slow Deceleration
Stalls (Except Whip Stalls) . . . . .	Use Slow Deceleration

\* Higher speeds can be used if abrupt use of the controls is avoided.

Aerobatics that may impose high loads should not be attempted. The important thing to bear in mind in flight maneuvers is that the airplane is clean in aerodynamic design and will build up speed quickly with the nose down. Proper speed control is an essential requirement for execution of any maneuver, and care should always be exercised to avoid excessive speed which in turn can impose excessive loads. In the execution of all maneuvers, avoid abrupt use of controls.

## FLIGHT LOAD FACTOR LIMITS

Flight Load Factors:

- \*Flaps Up: +4.4g, -1.76g
- \*Flaps Down: +3.5g

\*The design load factors are 150% of the above, and in all cases, the structure meets or exceeds design loads.

## KINDS OF OPERATION LIMITS

The airplane is equipped for day VFR and may be equipped for night VFR and/or IFR operations. FAR Part 91 establishes the minimum required instrumentation and equipment for these operations. The reference to types of flight operations on the operating limitations placard re-

fleets equipment installed at the time of Airworthiness Certificate issuance.

Flight into known icing conditions is prohibited.

## FUEL LIMITATIONS

2 Standard Tanks: 13 U.S. gallons each.

Total Fuel: 26 U. S. gallons.

Usable Fuel (all flight conditions): 22. 5 U.S. gallons.

Unusable Fuel: 3. 5 U. S. gallons

2 Long Range Tanks: 19 U. S. gallons each.

Total Fuel: 38 U. S. gallons.

Usable Fuel (all flight conditions): 35 U.S. gallons.

Unusable Fuel: 3. 0 U.S. gallons.

### NOTE

Due to cross-feeding between fuel tanks, the tanks should be re-topped after each refueling to assure maximum capacity.

Approved Fuel Grades (and Colors):

80 (Formerly 80/87) Grade Aviation Fuel (Red).

100LL Grade Aviation Fuel (Blue).

100 (Formerly 100/130) Grade Aviation Fuel (Green)

## PLACARDS

The following information is displayed in the form of composite or individual placards.

(1) In full view of the pilot: (The "DAY-NIGHT-VFR-IFR" entry, shown on the example below, will vary as the airplane is equipped.)

This airplane is approved in the utility category and must be operated in compliance with the operating limitations as stated in the form of placards, markings and manuals.

—————MAXIMUMS—————

MANEUVERING SPEED (IAS)	97 knots
GROSS WEIGHT	1600 lbs
FLIGHT LOAD FACTOR	Flaps Up. . . . +4.4, -1.76
	Flaps Down . . . . +3. 5

NO ACROBATIC MANEUVERS APPROVED  
EXCEPT THOSE LISTED BELOW

Maneuver	Recm.	Entry Speed	Maneuver	Recm.	Entry Speed
Chandelles		95 knots	Spins		Slow Deceleration
Lazy Eights		95 knots	Stalls (except		
Steep Turns		95 knots	whip stalls).		Slow Deceleration

Abrupt use of controls prohibited above 97 knots.

Spin Recovery: opposite rudder - forward elevator - neutralize controls. Intentional spins with flaps extended are prohibited.

Flight into known icing conditions prohibited. This airplane is certified for the following flight operations as of date of original airworthiness certificate:

DAY - NIGHT - VFR - IFR

In the baggage compartment:

120 lb. maximum baggage and/or auxiliary seat passenger. For additional loading instructions see Weight and Balance Data.

- (3) Near fuel shut-off valve (standard tanks):

FUEL - 22.5 GALS - ON-OFF

- Near fuel shut-off valve (long range tanks):

FUEL - 35.0 GALS - ON-OFF

- (4) Near fuel tank filler cap (standard tanks):

FUEL  
80/87 MIN. GRADE AVIATION GASOLINE  
CAP. 13 U.S. GAL.

- Near fuel tank filler cap (long range tanks):

FUEL  
80/87 MIN. GRADE AVIATION GASOLINE  
CAP. 19 U.S. GAL.

- (5) On the instrument panel near over-voltage light:

HIGH VOLTAGE



# SECTION 3

# EMERGENCY PROCEDURES

## TABLE OF CONTENTS

	Page
Introduction . . . . .	3-3
Airspeeds For Emergency Operation. . . . .	3-3
<b>OPERATIONAL CHECKLISTS</b>	
Engine Failures . . . . .	3-3
Engine Failure During Takeoff Run. . . . .	3-3
Engine Failure Immediately After Takeoff. . . . .	3-3
Engine Failure During Flight. . . . .	3-4
Forced Landings. . . . .	3-4
Emergency Landing Without Engine Power. . . . .	3-4
Precautionary Landing With Engine Power. . . . .	3-4
Ditching. . . . .	3-4
Fires. . . . .	3-5
During Start On Ground. . . . .	3-5
Engine Fire in Flight. . . . .	3-5
Electrical Fire In Flight. . . . .	3-6
Cabin Fire. . . . .	3-6
Wing Fire. . . . .	3-7
Icing. . . . .	3-7
Inadvertent Icing Encounter. . . . .	3-7
Landing With a Flat Main Tire. . . . .	3-8
Electrical Power Supply System Malfunctions. . . . .	3-8
Over-Voltage Light Illuminates. . . . .	3-8
Ammeter Shows Discharge. . . . .	3-8

## AMPLIFIED PROCEDURES

Engine Failure. . . . .	3-9
Forced Landings. . . . .	3-10
Landing Without Elevator Control. . . . .	3-10
Fires. . . . .	3-10



**TABLE OF CONTENTS (Continued)**

	Page
Emergency Operation In Clouds (Vacuum System Failure)	3-11
Executing A 180° Turn In Clouds	3-11
Emergency Descent Through Clouds	3-11
Recovery From a Spiral Dive	3-12
Flight In Icing Conditions	3-12
Spins	3-12
Rough Engine Operation Or Loss Of Power	3-13
Carburetor Icing	3-13
Spark Plug Fouling	3-13
Magnetos Malfunction	3-14
Low Oil Pressure	3-14
Electrical Power Supply System Malfunctions	3-14
Excessive Rate Of Charge	3-14
Insufficient Rate Of Charge	3-15

## INTRODUCTION

Section 3 provides checklist and amplified procedures for coping with emergencies that may occur. Emergencies caused by airplane or engine malfunctions are extremely rare if proper preflight inspections and maintenance are practiced. Enroute weather emergencies can be minimized or eliminated by careful flight planning and good judgement when unexpected weather is encountered. However, should an emergency arise, the basic guidelines described in this section should be considered and applied as necessary to correct the problem. Emergency procedures associated with the ELT and other optional systems can be found in Section 9.

## AIRSPEEDS FOR EMERGENCY OPERATION

Engine Failure After Takeoff . . . . .	60 KIAS
Maneuvering Speed:	
1600 Lbs. . . . .	97 KIAS
1450 Lbs. . . . .	93 KIAS
1300 Lbs. . . . .	88 KIAS
Maximum Glide. . . . .	60 KIAS
Precautionary Landing With Engine Power. . . . .	55 KIAS
Landing Without Engine Power:	
Wing Flaps Up. . . . .	65 KIAS
Wing Flaps Down. . . . .	55 KIAS

## OPERATIONAL CHECKLISTS

### ENGINE FAILURES

#### ENGINE FAILURE DURING TAKEOFF RUN

- (1) Throttle - IDLE.
- (2) Brakes - APPLY.
- (3) Wing Flaps - RETRACT.
- (4) Mixture - IDLE CUT-OFF.
- (5) Ignition Switch - OFF.
- (6) Master Switch - OFF.

#### ENGINE FAILURE IMMEDIATELY AFTER TAKEOFF

- (1) Airspeed - 60 KIAS.
- (2) Mixture - IDLE CUT-OFF.
- (3) Fuel Shut off Valve --OFF.
- (4) Ignition Switch - OFF.

- (5) Wing Flaps -- AS REQUIRED.
- (6) Master Switch -- OFF.

### **ENGINE FAILURE DURING FLIGHT**

- (1) Airspeed --60 KIAS.
- (2) Carburetor Heat — ON.
- (3) Primer — IN and LOCKED.
- (4) Fuel Shutoff Valve — ON.
- (5) Mixture — RICH.
- (6) Ignition Switch - BOTH (or START if propeller is stopped).

## **FORCED LANDINGS**

### **EMERGENCY LANDING WITHOUT ENGINE POWER**

- (1) Airspeed--65 KIAS (flaps UP).  
55 KIAS (flaps DOWN).
- (2) Mixture — IDLE CUT-OFF.
- (3) Fuel Shutoff Valve — OFF.
- (4) Ignition Switch — OFF.
- (5) Wing Flaps - AS REQUIRED (40° recommended).
- (6) Master Switch — OFF.
- (7) Doors — UNLATCH PRIOR TO TOUCHDOWN.
- (8) Touchdown - SLIGHTLY TAIL LOW.
- (9) Brakes — APPLY HEAVILY.

### **PRECAUTIONARY LANDING WITH ENGINE POWER**

- (1) Airspeed — 60 KIAS.
- (2) Wing Flaps - 20°.
- (3) Selected Field - FLY OVER, noting terrain and obstructions, then retract flaps upon reaching a safe altitude and airspeed.
- (4) Radio and Electrical Switches — OFF.
- (5) Wing Flaps - 40° (on final approach).
- (6) Airspeed — 55 KIAS.
- (7) Master Switch - OFF.
- (8) Doors — UNLATCH PRIOR TO TOUCHDOWN.
- (9) Touchdown — SLIGHTLY TAIL LOW.
- (10) Ignition Switch — OFF.
- (11) Brakes - APPLY HEAVILY.

### **DITCHING**

- (1) Radio — TRANSMIT MAYDAY on 121.5 MHz, giving location

and intentions.

- (2) Heavy Objects (in baggage area) — SECURE or JETTISON.
- (3) Approach — High Winds, Heavy Seas — INTO THE WIND.  
Light Winds, Heavy Swells - PARALLEL TO SWELLS.
- (4) Wing Flaps - 40°.
- (5) Power - ESTABLISH 300 FT/MIN DESCENT at 55 KIAS.
- (6) Cabin Doors -- UNLATCH.
- (7) Touchdown — LEVEL ATTITUDE AT 300 FT/MIN DESCENT.
- (8) Face — CUSHION at touchdown with folded coat.
- (9) Airplane — EVACUATE through cabin doors. If necessary, open window and flood cabin to equalize pressure so doors can be opened.
- (10) Life Vests and Raft - INFLATE.

## FIRES

### DURING START ON GROUND

(1) Cranking — CONTINUE, to get a start which would suck the flames and accumulated fuel through the carburetor and into the engine.

If engine starts:

- (2) Power — 1700 RPM for a few minutes.
- (3) Engine - SHUTDOWN and inspect for damage.

If engine fails to start:

- (4) Cranking — CONTINUE in an effort to obtain a start.
- (5) Fire Extinguisher — OBTAIN (have ground attendants obtain if not installed).
- (6) Engine — SECURE.
  - a. Master Switch -- OFF.
  - b. Ignition Switch -- OFF.
  - c. Fuel Shutoff Valve — OFF.
- (7) Fire — EXTINGUISH using fire extinguisher, wool blanket, or dirt.
- (8) Fire Damage — INSPECT, repair damage or replace damaged components or wiring before conducting another flight.

### ENGINE FIRE IN FLIGHT

- (1) Mixture - IDLE CUT-OFF.

- (2) Fuel Shutoff Valve - OFF.
- (3) Master Switch — OFF.
- (4) Cabin Heat and Air -- OFF (except wing root vents).
- (5) Airspeed — 85 KIAS (If fire is not extinguished, increase glide speed to find an airspeed which will provide an incombustible mixture).
- (6) Forced Landing -- EXECUTE (as described in Emergency Landing Without Engine Power).

### **ELECTRICAL FIRE IN FLIGHT**

- (1) Master Switch — OFF.
- (2) All Other Switches (except ignition switch) — OFF.
- (3) Vents/Cabin Air/Heat - CLOSED.
- (4) Fire Extinguisher — ACTIVATE (if available).

After discharging an extinguisher within a closed cabin, ventilate the cabin.

If fire appears out and electrical power is necessary for continuance of flight:

- (5) Master Switch- ON.
- (6) Circuit Breakers — -CHECK for faulty circuit, do not reset.
- (7) Radio/Electrical Switches — ON one at a time, with delay after each until short circuit is localized.
- (8) Vents/Cabin Air/Heat — OPEN when it is ascertained that fire is completely extinguished.

### **CABIN FIRE**

- (1) Master Switch -- OFF.
- (2) Vents/Cabin Air/Heat — CLOSED (to avoid drafts).
- (3) Fire Extinguisher — ACTIVATE (if available).



After discharging an extinguisher within a closed cabin, ventilate the cabin.

- (4) Land the airplane as soon as possible to inspect for damage.

## WING FIRE

- (1) Navigation Light Switch -- OFF.
- (2) Strobe Light Switch -- OFF.
- (3) Pitot Heat Switch -- OFF.

### NOTE

Perform a side slip to keep the flames away from the fuel tank and cabin, and land as soon as possible, with flaps retracted.

## ICING

### INADVERTENT ICING ENCOUNTER

- (1) Turn pitot heat switch ON (if installed).
- (2) Turn back or change altitude to obtain an outside air temperature that is less conducive to icing.
- (3) Pull cabin heat control full out to obtain maximum defroster air temperature. For greater air flow at reduced temperatures, adjust the cabin air control as required.
- (4) Open the throttle to increase engine speed and minimize ice build-up on propeller blades.
- (5) Watch for signs of carburetor air filter ice and apply carburetor heat as required. An unexpected loss in engine speed could be caused by carburetor ice or air intake filter ice. Lean the mixture for maximum RPM, if carburetor heat is used continuously.
- (6) Plan a landing at the nearest airport. With an extremely rapid ice build-up, select a suitable "off airport" landing site.
- (7) With an ice accumulation of 1/4 inch or more on the wing leading edges, be prepared for significantly higher stall speed.
- (8) Leave wing flaps retracted. With a severe ice build-up on the horizontal tail, the change in wing wake airflow direction caused by wing flap extension could result in a loss of elevator effectiveness.
- (9) Open left window and if practical scrape ice from a portion of the windshield for visibility in the landing approach.
- (10) Perform a landing approach using a forward slip, if necessary, for improved visibility.
- (11) Approach at 65 to 75 KIAS depending upon the amount of ice accumulation.
- (12) Perform a landing in level attitude.

## **LANDING WITH A FLAT MAIN TIRE**

- (1) Wing Flaps -- AS DESIRED.
- (2) Approach -- NORMAL.
- (3) Touchdown -- GOOD TIRE FIRST, hold airplane off flat tire as long as possible with aileron control.

## **ELECTRICAL POWER SUPPLY SYSTEM MALFUNCTIONS**

### **OVER-VOLTAGE LIGHT ILLUMINATES**

- (1) Master Switch -- OFF (both sides).
- (2) Master Switch -- ON.
- (3) Over-Voltage Light -- OFF.

If over-voltage light illuminates again:

- (4) Flight -- TERMINATE as soon as practical.

### **AMMETER SHOWS DISCHARGE**

- (1) Alternator - OFF.
- (2) Nonessential Electrical Equipment -- OFF.
- (3) Flight - TERMINATE as soon as practical.

## AMPLIFIED PROCEDURES

### ENGINE FAILURE

If an engine failure occurs during the takeoff run, the most important thing to do is stop the airplane on the remaining runway. Those extra items on the checklist will provide added safety during a failure of this type.

Prompt lowering of the nose to maintain airspeed and establish a glide attitude is the first response to an engine failure after takeoff. In most cases, the landing should be planned straight ahead with only small changes in direction to avoid obstructions. Altitude and airspeed are seldom sufficient to execute a 180° gliding turn necessary to return to the runway. The checklist procedures assume that adequate time exists to secure the fuel and ignition systems prior to touchdown.

After an engine failure in flight, the best glide speed as shown in Figure 3-1 should be established as quickly as possible. While gliding toward a suitable landing area, an effort should be made to identify the cause of the failure. If time permits, an engine restart should be attempted as shown in the checklist. If the engine cannot be restarted, a forced landing without power must be completed.

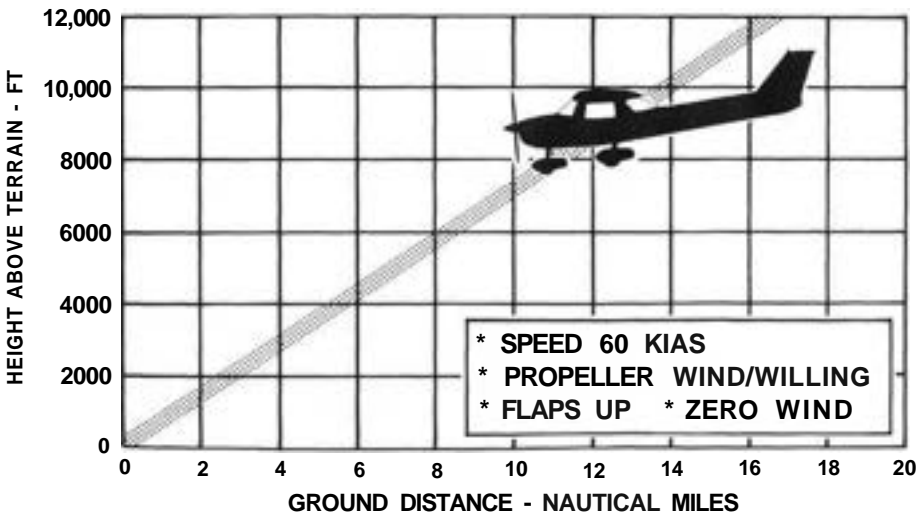

Figure 3-1. Maximum Glide



## FORCED LANDINGS

If all attempts to restart the engine fail and a forced landing is imminent, select a suitable field and prepare for the landing as discussed in the checklist for engine-off emergency landings.

Before attempting an "off airport" landing with engine power available, one should drag the landing area at a safe but low altitude to inspect the terrain for obstructions and surface conditions, proceeding as discussed under the Precautionary Landing With Engine Power checklist.

Prepare for ditching by securing or jettisoning heavy objects located in the baggage area and collect folded coats for protection of occupants' face at touchdown. Transmit Mayday message on 121.5 MHz giving location and intentions.

## LANDING WITHOUT ELEVATOR CONTROL

Trim for horizontal flight (with an airspeed of approximately 55 KIAS and flaps lowered to 20°) by using throttle and elevator trim controls. Then do not change the elevator trim control setting; control the glide angle by adjusting power exclusively.

At flareout, the nose-down moment resulting from power reduction is an adverse factor and the airplane may hit on the nose wheel. Consequently, at flareout, the trim control should be set at the full nose-up position and the power adjusted so that the airplane will rotate to the horizontal attitude for touchdown. Close the throttle at touchdown.

## FIRES

Although engine fires are extremely rare in flight, the steps of the appropriate checklist should be followed if one is encountered. After completion of this procedure, execute a forced landing. Do not attempt to restart the engine.

The initial indication of an electrical fire is usually the odor of burning insulation. The checklist for this problem should result in elimination of the fire.

## **EMERGENCY OPERATION IN CLOUDS (Vacuum System Failure)**

In the event of a vacuum system failure during flight in marginal weather, the directional indicator and attitude indicator will be disabled, and the pilot will have to rely on the turn coordinator or the turn and bank indicator if he inadvertently flies into clouds. The following instructions assume that only the electrically-powered turn coordinator or the turn and bank indicator is operative, and that the pilot is not completely proficient in instrument flying.

### **EXECUTING A 180° TURN IN CLOUDS**

Upon inadvertently entering the clouds, an immediate plan should be made to turn back as follows:

- (1) Note the time of the minute hand and observe the position of the sweep second hand on the clock.
- (2) When the sweep second hand indicates the nearest half-minute, initiate a standard rate left turn, holding the turn coordinator symbolic airplane wing opposite the lower left index mark for 60 seconds. Then roll back to level flight by leveling the miniature airplane.
- (3) Check accuracy of the turn by observing the compass heading which should be the reciprocal of the original heading.
- (4) If necessary, adjust heading primarily with skidding motions rather than rolling motions so that the compass will read more accurately.
- (5) Maintain altitude and airspeed by cautious application of elevator control. Avoid over controlling by keeping the hands off the control wheel as much as possible and steering only with rudder.

### **EMERGENCY DESCENT THROUGH CLOUDS**

If conditions preclude reestablishment of VFR flight by a 180° turn, a descent through a cloud deck to VFR conditions may be appropriate. If possible, obtain radio clearance for an emergency descent through clouds. To guard against a spiral dive, choose an easterly or westerly heading to minimize compass card swings due to changing bank angles. In addition, keep hands off the control wheel and steer a straight course with rudder control by monitoring the turn coordinator. Occasionally check the compass heading and make minor corrections to hold an approximate course. Before descending into the clouds, set up a stabilized let-down condition as follows:

- (1) Apply full rich mixture.
- (2) Use full carburetor heat.
- (3) Reduce power to set up a 500 to 800 ft/min rate of descent.
- (4) Adjust the elevator trim for a stabilized descent at 70 KIAS.
- (5) Keep hands off control wheel.
- (6) Monitor turn coordinator and make corrections by rudder alone.
- (7) Check trend of compass card movement and make cautious corrections with rudder to stop turn.
  
- (8) Upon breaking out of clouds, resume normal cruising flight.

### **RECOVERY FROM A SPIRAL DIVE**

If a spiral is encountered, proceed as follows:

- (1) Close the throttle.
- (2) Stop the turn by using coordinated aileron and rudder control to align the symbolic airplane in the turn coordinator with the horizon reference line.
- (3) Cautiously apply elevator back pressure to slowly reduce the airspeed to 70 KIAS.
- (4) Adjust the elevator trim control to maintain a 70 KIAS glide.
- (5) Keep hands off the control wheel, using rudder control to hold a straight heading.
- (6) Apply carburetor heat.
- (7) Clear engine occasionally, but avoid using enough power to disturb the trimmed glide.
- (8) Upon breaking out of clouds, resume normal cruising flight.

### **FLIGHT IN ICING CONDITIONS**

Flight into icing conditions is prohibited. An inadvertent encounter with these conditions can best be handled using the checklist procedures. The best procedure, of course, is to turn back or change altitude to escape icing conditions.

### **SPINS**

Should an inadvertent spin occur, the following recovery procedure should be used:

- (1) RETARD THROTTLE TO IDLE POSITION.
- (2) PLACE AILERONS IN NEUTRAL POSITION.

- (3) APPLY AND HOLD FULL RUDDER OPPOSITE TO THE DIRECTION OF ROTATION.
- (4) JUST AFTER THE RUDDER REACHES THE STOP, MOVE THE CONTROL WHEEL BRISKLY FORWARD FAR ENOUGH TO BREAK THE STALL. Full down elevator may be required at aft center of gravity loadings to assure optimum recoveries.
- (5) HOLD THESE CONTROL INPUTS UNTIL ROTATION STOPS. Premature relaxation of the control inputs may extend the recovery.
- (6) AS ROTATION STOPS, NEUTRALIZE RUDDER, AND MAKE A SMOOTH RECOVERY FROM THE RESULTING DIVE.

#### NOTE

If disorientation precludes a visual determination of the direction of rotation, the symbolic airplane in the turn coordinator or the needle of the turn and bank indicator may be referred to for this information.

For additional information on spins and spin recovery, see the discussion under SPINS in Normal Procedures (Section 4).

## **ROUGH ENGINE OPERATION OR LOSS OF POWER**

### **CARBURETOR ICING**

A gradual loss of RPM and eventual engine roughness may result from the formation of carburetor ice. To clear the ice, apply full throttle and pull the carburetor heat knob full out until the engine runs smoothly; then remove carburetor heat and readjust the throttle. If conditions require the continued use of carburetor heat in cruise flight, use the minimum amount of heat necessary to prevent ice from forming and lean the mixture slightly for smoothest engine operation.

### **SPARK PLUG FOULING**

A slight engine roughness in flight may be caused by one or more spark plugs becoming fouled by carbon or lead deposits. This may be verified by turning the ignition switch momentarily from BOTH to either L or R position. An obvious power loss in single ignition operation is evidence of spark plug or magneto trouble. Assuming that spark plugs are the more likely cause, lean the mixture to the recommended lean setting for cruising flight. If the problem does not clear up in several minutes, determine if a richer mixture setting will produce smoother operation. If not, proceed to the nearest airport for repairs using the BOTH

position of the ignition switch unless extreme roughness dictates the use of a single ignition position.

### **MAGNETO MALFUNCTION**

A sudden engine roughness or misfiring is usually evidence of magneto problems. Switching from BOTH to either L or R ignition switch position will identify which magneto is malfunctioning. Select different power settings and enrichen the mixture to determine if continued operation on BOTH magnetos is practicable. If not, switch to the good magneto and proceed to the nearest airport for repairs.

### **LOW OIL PRESSURE**

If low oil pressure is accompanied by normal oil temperature, there is a possibility the oil pressure gage or relief valve is malfunctioning. A leak in the line to the gage is not necessarily cause for an immediate precautionary landing because an orifice in this line will prevent a sudden loss of oil from the engine sump. However, a landing at the nearest airport would be advisable to inspect the source of trouble.

If a total loss of oil pressure is accompanied by a rise in oil temperature, there is good reason to suspect an engine failure is imminent. Reduce engine power immediately and select a suitable forced landing field. Use only the minimum power required to reach the desired touchdown spot.

## **ELECTRICAL POWER SUPPLY SYSTEM MALFUNCTIONS**

Malfunctions in the electrical power supply system can be detected by periodic monitoring of the ammeter and over-voltage warning light; however, the cause of these malfunctions is usually difficult to determine. Broken or loose alternator wiring is most likely the cause of alternator failures, although other factors could cause the problem. A damaged or improperly adjusted voltage regulator can also cause malfunctions. Problems of this nature constitute an electrical emergency and should be dealt with immediately. Electrical power malfunctions usually fall into two categories: excessive rate of charge and insufficient rate of charge. The paragraphs below describe the recommended remedy for each situation.

### **EXCESSIVE RATE OF CHARGE**

After engine starting and heavy electrical usage at low engine speeds (such as extended taxiing) the battery condition will be low enough to ac-

cept above normal charging during the initial part of a flight. However, after thirty minutes of cruising flight, the ammeter should be indicating less than two needle widths of charging current. If the charging rate were to remain above this value on a long flight, the battery would overheat and evaporate the electrolyte at an excessive rate. Electronic components in the electrical system could be adversely affected by higher than normal voltage if a faulty voltage regulator setting is causing the overcharging. To preclude these possibilities, an over-voltage sensor will automatically shut down the alternator and the over-voltage warning light will illuminate if the charge voltage reaches approximately 16 volts. Assuming that the malfunction was only momentary, an attempt should be made to reactivate the alternator system. To do this, turn both sides of the master switch off and then on again. If the problem no longer exists, normal alternator charging will resume and the warning light will go off. If the light comes on again, a malfunction is confirmed. In this event, the flight should be terminated and/or the current drain on the battery minimized because the battery can supply the electrical system for only a limited period of time. If the emergency occurs at night, power must be conserved for later use of the landing light and flaps during landing.

### **INSUFFICIENT RATE OF CHARGE**

If the ammeter indicates a continuous discharge rate in flight, the alternator is not supplying power to the system and should be shut down since the alternator field circuit may be placing an unnecessary load on the system. All nonessential equipment should be turned off and the flight terminated as soon as practical.

# SECTION 4

## NORMAL PROCEDURES

### TABLE OF CONTENTS

	Page
Introduction.. . . . .	4-3
Speeds For Normal Operation . . . . .	4-3

### CHECKLIST PROCEDURES

Preflight Inspection . . . . .	4-5
Cabin . . . . .	4-5
Empennage. . . . .	4-5
Right Wing, Trailing Edge. . . . .	4-5
Right Wing . . . . .	4-5
Nose. . . . .	4-5
Left Wing . . . . .	4-6
Left Wing, Leading Edge. . . . .	4-6
Left Wing, Trailing Edge. . . . .	4-6
Before Starting Engine. . . . .	4-6
Starting Engine. . . . .	4-7
Before Takeoff. . . . .	4-7
Takeoff . . . . .	4-7
Normal Takeoff. . . . .	4-7
Short Field Takeoff. . . . .	4-8
Enroute Climb. . . . .	4-8
Cruise. . . . .	4-8
Before Landing. . . . .	4-8
Landing . . . . .	4-8
Normal Landing . . . . .	4-8
Short Field Landing . . . . .	4-9
Balked Landing . . . . .	4-9
After Landing . . . . .	4-9
Securing Airplane. . . . .	4-9

### AMPLIFIED PROCEDURES

Starting Engine. . . . .	4-11
Taxiing . . . . .	4-11

## TABLE OF CONTENTS (Continued)

	Page
Before Takeoff . . . . .	4-13
Warm-Up . . . . .	4-13
Magnetos Check . . . . .	4-13
Alternator Check . . . . .	4-13
Takeoff . . . . .	4-13
Power Check . . . . .	4-13
Flap Settings . . . . .	4-14
Short Field Takeoff . . . . .	4-14
Crosswind Takeoff . . . . .	4-15
Enroute Climb . . . . .	4-15
Normal Climb . . . . .	4-15
Best Rate of Climb . . . . .	4-15
Best Angle of Climb . . . . .	4-15
Cruise . . . . .	4-15
Stalls . . . . .	4-17
Spins . . . . .	4-17
Landing . . . . .	4-19
Short Field Landing . . . . .	4-19
Crosswind Landing . . . . .	4-20
Balked Landing . . . . .	4-20
Cold Weather Operation . . . . .	4-20
Noise Abatement . . . . .	4-22



## INTRODUCTION

Section 4 provides checklist and amplified procedures for the conduct of normal operation. Normal procedures associated with Optional Systems can be found in Section 9.

## SPEEDS FOR NORMAL OPERATION

Unless otherwise noted, the following speeds are based on a maximum weight of 1600 pounds and may be used for any lesser weight.

### Takeoff:

Normal Climb Out	60-70 KIAS
Short Field Takeoff, Flaps Up, Speed at 50 Feet	60 KIAS

### Climb, Flaps Up:

Normal	65-75 KIAS
Best Rate of Climb, Sea Level	68 KIAS
Best Rate of Climb, 10,000 Feet	62 KIAS
Best Angle of Climb, Sea Level thru 10,000 Feet	56 KIAS

### Landing Approach:

Normal Approach, Flaps Up	60-70 KIAS
Normal Approach, Flaps 40°	50-60 KIAS
Short Field Approach, Flaps 40°	52 KIAS

### Balked Landing:

Maximum Power, Flaps 20°	55 KIAS
--------------------------	---------

### Maximum Recommended Turbulent Air Penetration Speed:

1600 Lbs.	97 KIAS
1450 Lbs.	93 KIAS
1300 Lbs.	88 KIAS

Maximum Demonstrated Crosswind Velocity	13 KNOTS
---	----------

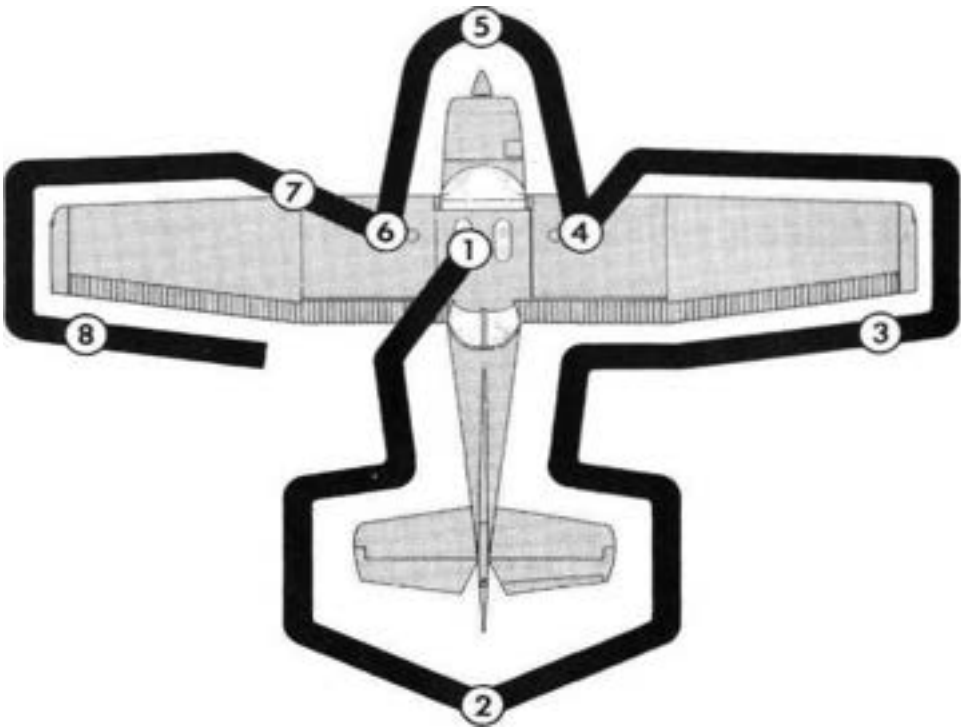

NOTE

Visually check airplane for general condition during walk-around inspection. In cold weather, remove even small accumulations of frost, ice or snow from wing, tail and control surfaces. Also, make sure that control surfaces contain no internal accumulations of ice or debris. If a night flight is planned, check operation of all lights, and make sure a flashlight is available.

Figure 4-1. Preflight Inspection

## CHECKLIST PROCEDURES

### PREFLIGHT INSPECTION

#### (1) CABIN

- (1) Control Wheel Lock -- REMOVE.
- (2) Ignition Switch -- OFF.
- (3) Master Switch -- ON.
- (4) Fuel Quantity Indicators -- CHECK QUANTITY.
- (5) Master Switch -- OFF.
- (6) Fuel Shutoff Valve -- ON.

#### (2) EMPENNAGE

- (1) Rudder Gust Lock - REMOVE.
- (2) Tail Tie-Down -- DISCONNECT.
- (3) Control Surfaces ~ CHECK freedom of movement and security.

#### (3) RIGHT WING **Trailing Edge**

- (1) Aileron - CHECK freedom of movement and security.

#### (4) RIGHT WING

- (1) Wing Tie-Down - DISCONNECT.
- (2) Main Wheel Tire ~ CHECK for proper inflation
- (3) Before first flight of the day and after each refueling, use sampler cup and drain small quantity of fuel from fuel tank sump quick-drain valve to check for water, sediment, and proper fuel grade .
- (4) Fuel Quantity - CHECK VISUALLY for desired level.
- (5) Fuel Filler Cap - SECURE.

#### (5) NOSE

- (1) Engine Oil Level — CHECK, do not operate with less than four quarts. Fill to six quarts for extended flight.
- (2) Before first flight of the day and after each refueling, pull out strainer drain knob for about four seconds to clear fuel strainer of possible water and sediment. Check strainer drain closed. If water is observed, the fuel system may contain additional water, and further draining of the system at the strainer, fuel tank sumps, and fuel line drain plug will be necessary.

- (3) Propeller and Spinner -- CHECK for nicks and security.
- (4) Carburetor Air Filter -- CHECK for restrictions by dust or other foreign matter.
- (5) Landing Light(s) -- CHECK for condition and cleanliness.
- (6) Nose Wheel Strut and Tire -- CHECK for proper inflation.
- (7) Nose Tie-Down -- DISCONNECT.
- (8) Static Source Opening (left side of fuselage) -- CHECK for stoppage.

**(6) LEFT WING**

- (1) Main Wheel Tire -- CHECK for proper inflation.
- (2) Before first flight of day and after each refueling, use sampler cup and drain small quantity of fuel from fuel tank sump quick-drain valve to check for water, sediment and proper fuel grade.
- (3) Fuel Quantity -- CHECK VISUALLY for desired level.
- (4) Fuel Filler Cap -- SECURE.

**(7) LEFT WING Leading Edge**

- (1) Pitot Tube Cover -- REMOVE and check opening for stoppage.
- (2) Stall Warning Opening -- CHECK for stoppage. To check the system, place a clean handkerchief over the vent opening and apply suction; a sound from the warning horn will confirm system operation.
- (3) Fuel Tank Vent Opening -- CHECK for stoppage.
- (4) Wing Tie-Down -- DISCONNECT.

**(8) LEFT WING Trailing Edge**

- (1) Aileron -- CHECK freedom of movement and security.

## **BEFORE STARTING ENGINE**

- (1) Preflight Inspection -- COMPLETE.
- (2) Seats, Belts, Shoulder Harnesses -- ADJUST and LOCK.
- (3) Fuel Shutoff Valve -- ON.
- (4) Radios, Electrical Equipment -- OFF.
- (5) Brakes -- TEST and SET.
- (6) Circuit Breakers -- CHECK IN.

## STARTING ENGINE

- (1) Mixture -- RICH.
- (2) Carburetor Heat -- COLD.
- (3) Master Switch -- ON.
- (4) Prime -- AS REQUIRED.
- (5) Throttle -- OPEN 1/4 INCH.
- (6) Propeller Area -- CLEAR.
- (7) Ignition Switch -- START (release when engine starts).
- (8) Oil Pressure -- CHECK.

## BEFORE TAKEOFF

- (1) Cabin Doors -- CLOSED and LATCHED,
- (2) Parking Brake -- SET.
- (3) Flight Controls -- FREE and CORRECT.
- (4) Flight Instruments -- SET.
- (5) Fuel Shutoff Valve -- ON.
- (6) Mixture -- RICH (below 5000 feet).
- (7) Elevator Trim -- TAKEOFF.
- (8) Throttle -- 1700 RPM.
  - a. Magnetos -- CHECK (RPM drop should not exceed 150 RPM on either magneto or 75 RPM differential between magnetos).
  - b. Carburetor Heat -- CHECK (for RPM drop).
  - c. Engine Instruments and Ammeter -- CHECK.
  - d. Suction Gage -- CHECK.
- (9) Radios -- SET.
- (10) Flashing Beacon, Navigation Lights and/or Strobe Lights -- ON as required.
- (11) Throttle Friction Lock -- ADJUST.

## TAKEOFF

### NORMAL TAKEOFF

- (1) Wing Flaps -- 0°
- (2) Carburetor Heat -- COLD.
- (3) Throttle -- FULL OPEN.
- (4) Elevator Control -- LIFT NOSE WHEEL at 50 KIAS.
- (5) Climb Speed -- 60-70 KIAS.

### **SHORT FIELD TAKEOFF**

- (1) Wing Flaps -- 0°.
- (2) Carburetor Heat -- COLD.
- (3) Brakes -- APPLY.
- (4) Throttle -- FULL OPEN.
- (5) Brakes -- RELEASE.
- (6) Elevator Control -- SLIGHTLY TAIL LOW.
- (7) Climb Speed -- 60 KIAS (With obstacles ahead).

### **ENROUTE CLIMB**

- (1) Airspeed -- 65-75 KIAS

#### **NOTE**

If a maximum performance climb is necessary, use speeds shown in the Rate Of Climb chart in Section 5.

- (2) Throttle -- FULL OPEN.
- (3) Mixture -- FULL RICH (mixture may be leaned above 5000 feet).

### **CRUISE**

- (1) Power -- 2000-2750 RPM (no more than 75%).
- (2) Elevator Trim - ADJUST.
- (3) Mixture - LEAN.

### **BEFORE LANDING**

- (1) Seats, Belts, Harnesses - ADJUST and LOCK.
- (2) Mixture - RICH.
- (3) Carburetor Heat - ON (apply full heat before closing throttle).

### **LANDING**

#### **NORMAL LANDING**

- (1) Airspeed - 60-70 KIAS (flaps UP).
- (2) Wing Flaps - AS DESIRED (below 85 KIAS).
- (3) Airspeed - 50-60 KIAS (flaps DOWN).

- (4) Touchdown -- MAIN WHEELS FIRST.
- (5) Landing Roll -- LOWER NOSE WHEEL GENTLY.
- (6) Braking -- MINIMUM REQUIRED.

### **SHORT FIELD LANDING**

- (1) Airspeed -- 60-70 KIAS (flaps UP).
- (2) Wing Flaps -- 40° (below 85 KIAS).
- (3) Airspeed -- MAINTAIN 52 KIAS.
- (4) Power -- REDUCE to idle as obstacle is cleared.
- (5) Touchdown -- MAIN WHEELS FIRST.
- (6) Brakes - APPLY HEAVILY.
- (7) Flaps -- RETRACT.

### **BALKED LANDING**

- (1) Throttle -- FULL OPEN.
- (2) Carburetor Heat -- COLD.
- (3) Wing Flaps -- RETRACT TO 20°.
- (4) Airspeed -- 55 KIAS.
- (5) Wing Flaps -- RETRACT (slowly).

### **AFTER LANDING**

- (1) Wing Flaps -- UP.
- (2) Carburetor Heat -- COLD.

### **SECURING AIRPLANE**

- (1) Parking Brake -- SET.
- (2) Radios, Electrical Equipment -- OFF.
- (3) Mixture -- IDLE CUT-OFF (pull full out).
- (4) Ignition Switch -- OFF.
- (5) Master Switch -- OFF.
- (6) Control Lock -- INSTALL.





## AMPLIFIED PROCEDURES

### STARTING ENGINE

Ordinarily the engine starts easily with one or two strokes of primer in warm temperatures to six strokes in cold weather, with the throttle open approximately 1/4 inch. In extremely cold temperatures, it may be necessary to continue priming while cranking.

Weak intermittent firing followed by puffs of black smoke from the exhaust stack indicate overpriming or flooding. Excess fuel can be cleared from the combustion chambers by the following procedure: Set mixture control in the idle cut-off position, throttle full open, and crank the engine through several revolutions with the starter. Repeat the starting procedure without any additional priming.

If the engine is underprimed (most likely in cold weather with a cold engine) it will not fire at all, and additional priming will be necessary. As soon as the cylinders begin to fire, open the throttle slightly to keep it running.

After starting, if the oil gage does not begin to show pressure within 30 seconds in the summertime and about twice that long in very cold weather, stop engine and investigate. Lack of oil pressure can cause serious engine damage. After starting, avoid the use of carburetor heat unless icing conditions prevail.

### TAXIING

When taxiing, it is important that speed and use of brakes be held to a minimum and that all controls be utilized (see Taxiing Diagram, Figure 4-2) to maintain directional control and balance.

The carburetor heat control knob should be pushed full in during all ground operations unless heat is absolutely necessary. When the knob is pulled out to the heat position, air entering the engine is not filtered.

Taxiing over loose gravel or cinders should be done at low engine speed to avoid abrasion and stone damage to the propeller tips.

The nose wheel is designed to automatically center straight ahead when the nose strut is fully extended. In the event the nose strut is over-

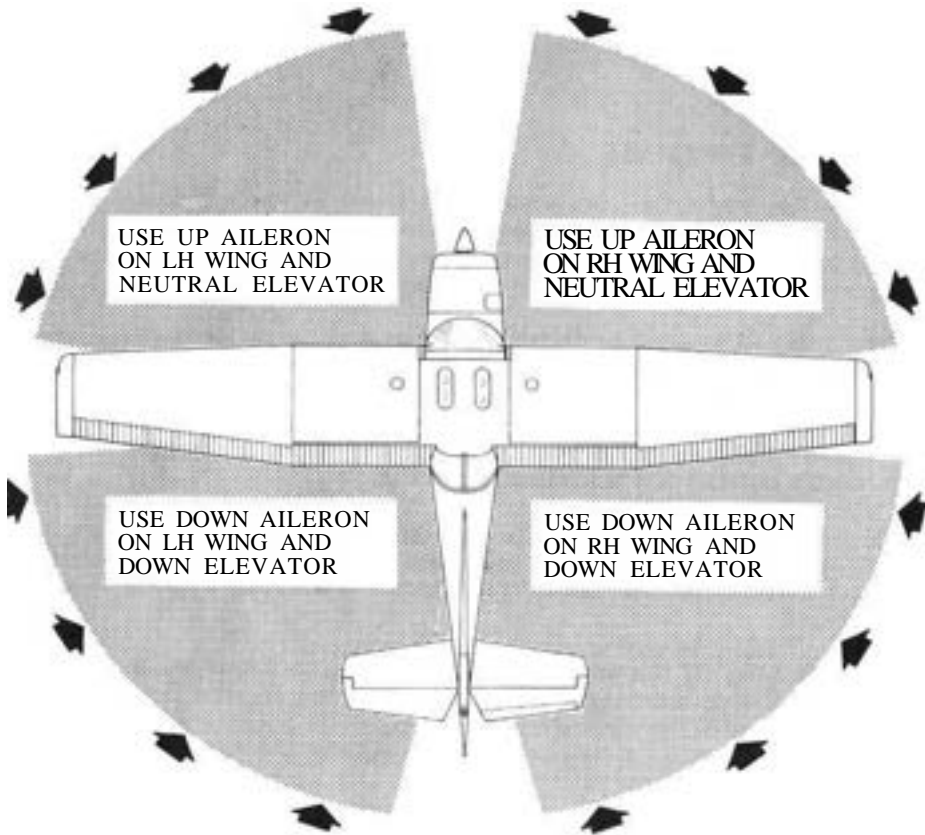

CODE

WIND DIRECTION



NOTE

Strong quartering tail winds require caution. Avoid sudden bursts of the throttle and sharp braking when the airplane is in this attitude. Use the steerable nose wheel and rudder to maintain direction.

Figure 4-2. Taxiing Diagram

inflated and the airplane is loaded to a rearward center of gravity position, it may be necessary to partially compress the strut to permit steering. This can be accomplished prior to taxiing by depressing the airplane nose (by hand) or during taxi by sharply applying brakes.

## **BEFORE TAKEOFF**

### **WARM-UP**

Most of the warm-up will have been conducted during taxi, and additional warm-up before takeoff should be restricted to the checklist procedures. Since the engine is closely cowled for efficient in-flight cooling, precautions should be taken to avoid overheating on the ground.

### **MAGNETO CHECK**

The magneto check should be made at 1700 RPM as follows: Move ignition switch first to R position and note RPM. Next move switch back to BOTH to clear the other set of plugs. Then move switch to the L position, note RPM and return the switch to the BOTH position. RPM drop should not exceed 150 RPM on either magneto or show greater than 75 RPM differential between magnetos. If there is a doubt concerning operation of the ignition system, RPM checks at higher engine speeds will usually confirm whether a deficiency exists.

An absence of RPM drop may be an indication of faulty grounding of one side of the ignition system or should be cause for suspicion that the magneto timing is set in advance of the setting specified.

### **ALTERNATOR CHECK**

Prior to flights where verification of proper alternator and voltage regulator operation is essential (such as night or instrument flights), a positive verification can be made by loading the electrical system momentarily (3 to 5 seconds) with the landing light, or by operating the wing flaps during the engine runup (1700 RPM). The ammeter will remain within a needle width of its initial position if the alternator and voltage regulator are operating properly.

## **TAKEOFF**

### **POWER CHECK**

It is important to check full-throttle engine operation early in the

takeoff run. Any sign of rough engine operation or sluggish engine acceleration is good cause for discontinuing the takeoff. If this occurs, you are justified in making a thorough full-throttle static runup before another takeoff is attempted. The engine should run smoothly and turn approximately 2460 to 2560 RPM with carburetor heat off and mixture full rich.

#### NOTE

At higher airport altitudes, this check should be made with the mixture leaned to provide maximum engine RPM.

Full throttle runups over loose gravel are especially harmful to propeller tips. When takeoffs must be made over a gravel surface, it is very important that the throttle be advanced slowly. This allows the airplane to start rolling before high RPM is developed, and the gravel will be blown back of the propeller rather than pulled into it. When unavoidable small dents appear in the propeller blades, they should be immediately corrected as described in Section 8 under Propeller Care.

Prior to takeoff from fields above 5000 feet elevation, the mixture should be leaned to give maximum RPM in a full-throttle, static runup.

After full throttle is applied, adjust the throttle friction lock clockwise to prevent the throttle from creeping back from a maximum power position. Similar friction lock adjustment should be made as required in other flight conditions to maintain a fixed throttle setting.

#### FLAP SETTINGS

Normal and short field takeoffs are performed with flaps up. The use of 10° flaps will shorten the ground run approximately 10%, but this advantage is lost in the climb to a 50-foot obstacle. Therefore, the use of 10° flaps is reserved for minimum ground runs or for takeoff from soft or rough fields.

If 10° of flaps are used on soft or rough fields with obstacles ahead, it is preferable to leave them extended rather than retract them in the climb to the obstacle. The exception to this rule would be in a high altitude takeoff in hot weather where climb would be marginal with flaps 10°. Flap deflections greater than 10° are not approved for takeoff.

#### SHORT FIELD TAKEOFF

If an obstruction dictates the use of a steep climb angle, after liftoff

accelerate to and climb out at an obstacle clearance speed of 60 KIAS with flaps retracted. This speed provides the best overall climb speed to clear obstacles when taking into account the turbulence often found near ground level.

## **CROSSWIND TAKEOFF**

Takeoffs into strong crosswinds normally are performed with the minimum flap setting necessary for the field length, to minimize the drift angle immediately after takeoff. The airplane is accelerated to a speed slightly higher than normal, then pulled off abruptly to prevent possible settling back to the runway while drifting. When clear of the ground, make a coordinated turn into the wind to correct for drift.

## **ENROUTE CLIMB**

When conducting the following climbs, the mixture should be full rich below 5000 feet and may be leaned, if necessary, above 5000 feet for smoother engine operation.

### **NORMAL CLIMB**

Normal climbs are conducted at 65 to 75 KIAS with flaps up and full throttle for best engine cooling.

### **BEST RATE OF CLIMB**

The best rate of climb speeds range from 68 KIAS at sea level to 62 KIAS at 10,000 feet with flaps up and full throttle.

### **BEST ANGLE OF CLIMB**

If enroute terrain dictates the use of a steep climb angle, climb at the best angle of climb speed of 56 KIAS with flaps up and full throttle.

#### **NOTE**

Steep climbs at low airspeeds should be of short duration to allow improved engine cooling.

## **CRUISE**

Normal cruising is performed between 55% and 75% power. The en-

gine RPM and corresponding fuel consumption for various altitudes can be determined by using your Cessna Power Computer or the data in Section 5.

NOTE

Cruising should be done at 65% to 75% power until a total of 50 hours has accumulated or oil consumption has stabilized. This is to ensure proper seating of the rings and is applicable to new engines, and engines in service following cylinder replacement or top overhaul of one or more cylinders.

The data in Section 5 shows the increased range and improved fuel economy that is obtainable when operating at lower power settings and higher altitudes. The use of lower power settings and the selection of cruise altitude on the basis of the most favorable wind conditions are significant factors that should be considered on every trip to reduce fuel consumption.

The Cruise Performance Table, Figure 4-3, shows the true airspeed and nautical miles per gallon during cruise for various altitudes and percent powers. This table should be used as a guide, along with the available winds aloft information, to determine the most favorable altitude and power setting for a given trip.

To achieve the recommended lean mixture fuel consumption figures shown in Section 5, the mixture should be leaned as follows:

- (1) Pull the mixture control out until engine RPM peaks and begins to fall off.
- (2) Enrichen slightly back to peak RPM.

ALTITUDE	75% POWER		65% POWER		55% POWER	
	KTAS	NMPG	KTAS	NMPG	KTAS	NMPG
Sea Level	100	17.9	94	19.2	88	21.0
3500 Feet	103	18.4	97	19.8	91	21.7
7000 Feet	106	18.9	100	20.4	94	22.4
Standard Conditions					Zero Wind	

Figure 4-3. Cruise Performance Table

For best fuel economy at 65% power or less, operate at the leanest mixture that results in smooth engine operation or at 50 RPM on the lean side of the peak RPM, whichever occurs first. This will result in approximately 5% greater range than shown in this handbook.

Carburetor ice, as evidenced by an unexplained drop in RPM, can be removed by application of full carburetor heat. Upon regaining the original RPM (with heat off), use the minimum amount of heat (by trial and error) to prevent ice from forming. Since the heated air causes a richer mixture, readjust the mixture setting when carburetor heat is to be used continuously in cruise flight.

The use of full carburetor heat is recommended during flight in very heavy rain to avoid the possibility of engine stoppage due to excessive water ingestion. The mixture setting should be readjusted for smoothest operation.

## **STALLS**

The stall characteristics are conventional for the flaps up and flaps down condition. Slight elevator buffeting may occur just before the stall with flaps down. The stall warning horn produces a steady signal 5 to 10 knots before the actual stall is reached and remains on until the airplane flight attitude is changed. Stall speeds for various combinations of flap setting and bank angle are summarized in Section 5.

## **SPINS**

Intentional spins are approved in this airplane (see Section 2). Before attempting to perform spins, however, several items should be carefully considered to assure a safe flight. No spins should be attempted without first having received dual instruction in both spin entries and spin recoveries from a qualified instructor who is familiar with the spin characteristics of the Cessna 150M.

The cabin should be clean and all loose equipment (including the microphone) should be stowed. For a solo flight in which spins will be conducted, the copilot's seat belt and shoulder harness should be secured. Spins with baggage loadings or occupied child's seat are not approved.

The seat belts and shoulder harnesses should be adjusted to provide proper restraint during all anticipated flight conditions. However,, care

should be taken to ensure that the pilot can easily reach the flight controls and produce maximum control travels.

It is recommended that, where feasible, entries be accomplished at high enough altitude that recoveries are completed 4000 feet or more above ground level. At least 1000 feet of altitude loss should be allowed for a 1-turn spin and recovery, while a 6-turn spin and recovery may require somewhat more than twice that amount. For example, the recommended entry altitude for a 6-turn spin would be 6000 feet above ground level. In any case, entries should be planned so that recoveries are completed well above the minimum 1500 feet above ground level required by FAR 91.71. Another reason for using high altitudes for practicing spins is that a greater field of view is provided which will assist in maintaining pilot orientation.

The normal entry is made from a power-off stall. As the stall is approached, the elevator control should be smoothly pulled to the full aft position. Just prior to reaching the stall "break", rudder control in the desired direction of the spin rotation should be applied so that full rudder deflection is reached almost simultaneously with reaching full aft elevator. A slightly greater rate of deceleration than for normal stall entries or the use of partial power at the entry will assure more consistent and positive entries to the spin. Care should be taken to avoid using aileron control since its application can increase the rotation rate and cause erratic rotation. Both elevator and rudder controls should be held full with the spin until the spin recovery is initiated. An inadvertent relaxation of either of these controls could result in the development of a nose-down spiral.

For the purpose of training in spins and spin recoveries, a 1 to 2-turn spin is adequate and should be used. Up to 2 turns, the spin will progress to a fairly rapid rate of rotation and a steep attitude. Application of recovery controls will produce prompt recoveries of from 1/4 to 1/2 of a turn.

If the spin is continued beyond the 2 to 3-turn range, some change in character of the spin may be noted. Rotation rates may vary and some additional sideslip may be felt. Normal recoveries from such extended spins may take up to a full turn or more.

Regardless of how many turns the spin is held or how it is entered, the following recovery technique should be used:

- (1) VERIFY THAT THROTTLE IS IN IDLE POSITION AND AILERONS ARE NEUTRAL.
- (2) APPLY AND HOLD FULL RUDDER OPPOSITE TO THE DIRECTION OF ROTATION.



- (3) JUST AFTER THE RUDDER REACHES THE STOP, MOVE THE CONTROL WHEEL BRISKLY FORWARD FAR ENOUGH TO BREAK THE STALL. Full down elevator may be required at aft center of gravity loadings to assure optimum recoveries.
- (4) HOLD THESE CONTROL INPUTS UNTIL ROTATION STOPS. Premature relaxation of the control inputs may extend the recovery.
- (5) AS ROTATION STOPS, NEUTRALIZE RUDDER, AND MAKE A SMOOTH RECOVERY FROM THE RESULTING DIVE.

#### NOTE

If disorientation precludes a visual determination of the direction of rotation, the symbolic airplane in the turn coordinator or the needle of the turn and bank indicator may be referred to for this information.

Variations in basic airplane rigging or in weight and balance due to installed equipment or cockpit occupancy can cause differences in behavior, particularly in extended spins. These differences are normal and will result in variations in the spin characteristics and in the recovery lengths for spins of more than 3 turns. However, the above recovery procedure should always be used and will result in the most expeditious recovery from any spin.

Intentional spins with flaps extended are prohibited, since the high speeds which may occur during recovery are potentially damaging to the flap/wing structure.

## LANDING

Normal landing approaches can be made with power-on or power-off at speeds of 60 to 70 KIAS with flaps up, and 50 to 60 KIAS with flaps down. Surface winds and air turbulence are usually the primary factors in determining the most comfortable approach speeds.

Actual touchdown should be made with power-off and on the main wheels first. The nose wheel should be lowered smoothly to the runway as speed is diminished.

### SHORT FIELD LANDING

For a short field landing in smooth air conditions, make an approach at 52 KIAS with 40° flaps using enough power to control the glide path. After all approach obstacles are cleared, progressively re-

duce power and maintain 52 KIAS by lowering the nose of the airplane. Touchdown should be made with power-off and on the main wheels first. Immediately after touchdown, lower the nose wheel and apply heavy braking as required. For maximum brake effectiveness, retract the flaps, hold full nose-up elevator, and apply maximum brake pressure without sliding the tires.

Slightly higher approach speeds should be used under turbulent air conditions.

### **CROSSWIND LANDING**

When landing in a strong crosswind, use the minimum flap setting required for the field length. Use a wing low, crab, or a combination method of drift correction and land in a nearly level attitude.

### **BALKED LANDING**

In a balked landing (go-around) climb, the wing flap setting should be reduced to 20° immediately after full power is applied. Upon reaching a safe airspeed, the flaps should be slowly retracted to the full up position.

## **COLD WEATHER OPERATION**

Prior to starting on cold mornings, it is advisable pull the propeller through several times by hand to "break loose" or "limber" the oil, thus conserving battery energy.

### **NOTE**

When pulling the propeller through by hand, treat it as if the ignition switch is turned on. A loose or broken ground wire on either magneto could cause the engine to fire.

In extremely cold (-18°C and lower) weather, the use of an external preheater is recommended whenever possible to reduce wear and abuse to the engine and electrical system.

Cold weather starting procedures are as follows:

#### With Preheat:

- (1) With ignition switch OFF and throttle closed, prime the engine four to ten strokes as the propeller is being turned over by hand.

NOTE

Use heavy strokes of primer for best atomization of fuel. After priming, push primer all the way in and turn to locked position to avoid possibility of engine drawing fuel through the primer.

- (2) Propeller Area -- CLEAR.
- (3) Master Switch -- ON.
- (4) Mixture -- FULL RICH
- (5) Throttle -- OPEN 1/4 INCH.
- (6) Ignition Switch -- START.
- (7) Release ignition switch to BOTH when engine starts.
- (8) Oil Pressure -- CHECK.

Without Preheat:

- (1) Prime the engine eight to ten strokes while the propeller is being turned by hand with the throttle closed. Leave the primer charged and ready for a stroke.
- (2) Propeller Area -- CLEAR.
- (3) Master Switch -- ON.
- (4) Mixture -- FULL RICH.
- (5) Ignition Switch -- START.
- (6) Pump throttle rapidly to full open twice. Return to 1/4 inch open position.
- (7) Release ignition switch to BOTH when engine starts.
- (8) Continue to prime engine until it is running smoothly, or alternately, pump throttle rapidly over first 1/4 of total travel.
- (9) Oil Pressure -- CHECK.
- (10) Pull carburetor heat knob full on after engine has started. Leave on until engine is running smoothly.
- (11) Primer -- LOCK.

NOTE

If the engine does not start during the first few attempts, or if engine firing diminishes in strength, it is probable that the spark plugs have been frosted over. Preheat must be used before another start is attempted.

**CAUTION**

Pumping the throttle may cause raw fuel to accumulate in the intake air duct, creating a fire hazard in the event

of a backfire. If this occurs, maintain a cranking action to suck flames into the engine. An outside attendant with a fire extinguisher is advised for cold starts without pre-heat.

During cold weather operations no indication will be apparent on the oil temperature gage prior to takeoff if outside air temperatures are very cold. After a suitable warm-up period (2 to 5 minutes at 1000 RPM), accelerate the engine several times to higher engine RPM. If the engine accelerates smoothly and the oil pressure remains normal and steady, the airplane is ready for takeoff.

When operating in temperatures below  $-18^{\circ}\text{C}$ , avoid using partial carburetor heat. Partial heat may increase the carburetor air temperature to the  $0^{\circ}$  to  $21^{\circ}\text{C}$  range, where icing is critical under certain atmospheric conditions.

## **NOISE ABATEMENT**

Increased emphasis on improving the quality of our environment requires renewed effort on the part of all pilots to minimize the effect of airplane noise on the public.

We, as pilots, can demonstrate our concern for environmental improvement, by application of the following suggested procedures, and thereby tend to build public support for aviation:

- (1) Pilots operating aircraft under VFR over outdoor assemblies of persons, recreational and park areas, and other noise-sensitive areas should make every effort to fly not less than 2000 feet above the surface, weather permitting, even though flight at a lower level may be consistent with the provisions of government regulations.
- (2) During departure from or approach to an airport, climb after takeoff and descent for landing should be made so as to avoid prolonged flight at low altitude near noise-sensitive areas.

### **NOTE**

The above recommended procedures do not apply where they would conflict with Air Traffic Control clearances or instructions, or where, in the pilot's judgment, an altitude of less than 2000 feet is necessary for him to adequately exercise his duty to see and avoid other aircraft.

# SECTION 5 PERFORMANCE

## TABLE OF CONTENTS

	Page
Introduction	5-3
Use of Performance Charts	5-3
Sample Problem	5-3
Takeoff	5-4
Cruise	5-5
Fuel Required	5-5
Landing	5-7
Figure 5-1, Airspeed Calibration	5-8
Figure 5-2, Temperature Conversion Chart	5-9
Figure 5-3, Stall Speeds	5-10
Figure 5-4, Takeoff Distance	5-11
Figure 5-5, Rate of Climb	5-12
Figure 5-6, Time, Fuel, and Distance to Climb	5-13
Figure 5-7, Cruise Performance	5-14
Figure 5-8, Range Profile - 22.5 Gallons Fuel	5-15
Range Profile - 35.0 Gallons Fuel	5-16
Figure 5-9, Endurance Profile - 22.5 Gallons Fuel	5-17
Endurance Profile - 35.0 Gallons Fuel	5-18
Figure 5-10, Landing Distance	5-19



## INTRODUCTION

Performance data charts on the following pages are presented so that you may know what to expect from the airplane under various conditions, and also, to facilitate the planning of flights in detail and with reasonable accuracy. The data in the charts has been computed from actual flight tests with the airplane and engine in good condition and using average piloting techniques.

It should be noted that the performance information presented in the range and endurance profile charts allows for 45 minutes reserve fuel based on 45% power. Fuel flow data for cruise is based on the recommended lean mixture setting. Some indeterminate variables such as mixture leaning technique, fuel metering characteristics, engine and propeller condition, and air turbulence may account for variations of 10% or more in range and endurance. Therefore, it is important to utilize all available information to estimate the fuel required for the particular flight.

## USE OF PERFORMANCE CHARTS

Performance data is presented in tabular or graphical form to illustrate the effect of different variables. Sufficiently detailed information is provided in the tables so that conservative values can be selected and used to determine the particular performance figure with reasonable accuracy.

## SAMPLE PROBLEM

The following sample flight problem utilizes information from the various charts to determine the predicted performance data for a typical flight. The following information is known:

### AIRPLANE CONFIGURATION

Takeoff weight	1525 Pounds
Usable fuel	22.5 Gallons

### TAKEOFF CONDITIONS

Field pressure altitude	1500 Feet
Temperature	28°C (16°C above standard)
Wind component along runway	12 Knot Headwind
Field length	3500 Feet

**CRUISE CONDITIONS**

Total distance	330 Nautical Miles
Pressure altitude	5500 Feet
Temperature	20°C (16°C above standard)
Expected wind enroute	10 Knot Headwind

**LANDING CONDITIONS**

Field pressure altitude	2000 Feet
Temperature	25° C
Field length	3000 Feet

**TAKEOFF**

The takeoff distance chart, figure 5-4, should be consulted, keeping in mind that the distances shown are based on the short field technique. Conservative distances can be established by reading the chart at the next higher value of altitude and temperature. For example, in this particular sample problem, the takeoff distance information presented for a pressure altitude of 2000 feet and a temperature of 30°C should be used and results in the following:

Ground roll	990 Feet
Total distance to clear a 50-foot obstacle	1865 Feet

These distances are well within the available takeoff field length. However, a correction for the effect of wind may be made based on Note 3 of the takeoff chart. The correction for a 12 knot headwind is:

$$\frac{12 \text{ Knots}}{9 \text{ Knots}} \quad 10\% = 13\% \text{ Decrease}$$

This results in the following distances, corrected for wind:

Ground roll, zero wind	990
Decrease in ground roll (990 feet x 13%)	<u>129</u>
Corrected ground roll	861 Feet

Total distance to clear a 50-foot obstacle, zero wind	1865
Decrease in total distance (1865 feet x 13%)	<u>242</u>
Corrected total distance to clear 50-foot obstacle	1623 Feet



## CRUISE

The cruising altitude should be selected based on a consideration of trip length, winds aloft, and the airplane's performance. A typical cruising altitude and the expected wind enroute have been given for this sample problem. However, the power setting selection for cruise must be determined based on several considerations. These include the cruise performance characteristics presented in figure 5-7, the range profile chart presented in figure 5-8, and the endurance profile chart presented in figure 5-9.

The relationship between power and range is illustrated by the range profile chart. Considerable fuel savings and longer range result when lower power settings are used.

The range profile chart indicates that use of 60% power at 5500 feet yields a predicted range of 385 nautical miles under no wind conditions. The endurance profile chart, figure 5-9, shows a corresponding 4.1 hours.

The range figure of 385 nautical miles is corrected to account for the expected 10 knot headwind at 5500 feet.

Range, zero wind	385
Decrease in range due to wind (4.1 hours x 10 knot headwind)	<u>41</u>
Corrected range	344 Nautical Miles

This indicates that the trip can be made without a fuel stop using approximately 60% power.

The cruise performance chart, figure 5-7, is entered at 6000 feet altitude and 20°C above standard temperature. These values most nearly correspond to the planned altitude and expected temperature conditions. The engine speed chosen is 2600 RPM, which results in the following:

Power	60%
True airspeed	98 Knots
Cruise fuel flow	4.5 GPH

The power computer may be used to determine power and fuel consumption more accurately during the flight.

## FUEL REQUIRED

The total fuel requirement for the flight may be estimated using the

performance information in figures 5-6 and 5-7. For this sample problem, figure 5-6 shows that a climb from 2000 feet to 6000 feet requires 1.1 gallons of fuel. The corresponding distance during the climb is 9 nautical miles. These values are for a standard temperature (as shown on the climb chart) and are sufficiently accurate for most flight planning purposes. However, a further correction for the effect of temperature may be made as noted on the climb chart. The approximate effect of a non-standard temperature is to increase the time, fuel, and distance by 10% for each 8°C above standard temperature, due to the lower rate of climb. In this case, assuming a temperature 16°C above standard, the correction would be:

$$\frac{16^{\circ}\text{C}}{8^{\circ}\text{C}} \times 10\% = 20\% \text{ Increase}$$

With this factor included, the fuel estimate would be calculated as follows:

Fuel to climb, standard temperature	1.1
Increase due to non-standard temperature (1.1 x 20%)	<u>0.2</u>
Corrected fuel to climb	1.3 Gallons

Using a similar procedure for the distance to climb results in 11 nautical miles.

The resultant cruise distance is:

Total distance	330
Climb distance	<u>-11</u>
Cruise distance	319 Nautical Miles

With an expected 10 knot headwind, the ground speed for cruise is predicted to be:

$$\begin{array}{r} 98 \\ -10 \\ \hline 88 \text{ Knots} \end{array}$$

Therefore, the time required for the cruise portion of the trip is:

$$\frac{319 \text{ Nautical Miles}}{88 \text{ Knots}} = 3.6 \text{ Hours}$$

The fuel required for cruise is:

$$3.6 \text{ hours} \times 4.5 \text{ gallons/hour} = 16.2 \text{ Gallons}$$

The total estimated fuel required is as follows:

Engine start, taxi, and takeoff	0.8
Climb	1.3
Cruise	<u>16.2</u>
Total fuel required	18.3 Gallons

This will leave a fuel reserve of:

$$\begin{array}{r} 22.5 \\ -18.3 \\ \hline 4.2 \text{ Gallons} \end{array}$$

Once the flight is underway, ground speed checks will provide a more accurate basis for estimating the time enroute and the corresponding fuel required to complete the trip with ample reserve.

## LANDING

A procedure similar to takeoff should be used for estimating the landing distance at the destination airport. Figure 5-10 presents landing distances for various airport altitude and temperature combinations using the short field technique. The distances corresponding to 2000 feet and 30°C are as follows:

Ground roll	505 Feet
Total distance to clear a 50-foot obstacle	1165 Feet

A correction for the effect of wind may be made based on Note 2 of the landing chart using the same procedure as outlined for takeoff.

## AIRSPEED CALIBRATION

FLAPS UP											
KIAS	40	50	60	70	80	90	100	110	120	130	140
KCAS	43	51	59	68	77	87	98	108	118	129	140
FLAPS 10°											
KIAS	40	50	60	70	80	85					
KCAS	42	50	60	69	78	82					
FLAPS 40°											
KIAS	40	50	60	70	80	85					
KCAS	40	50	61	72	83	89					

Figure 5-1. Airspeed Calibration

# TEMPERATURE CONVERSION CHART

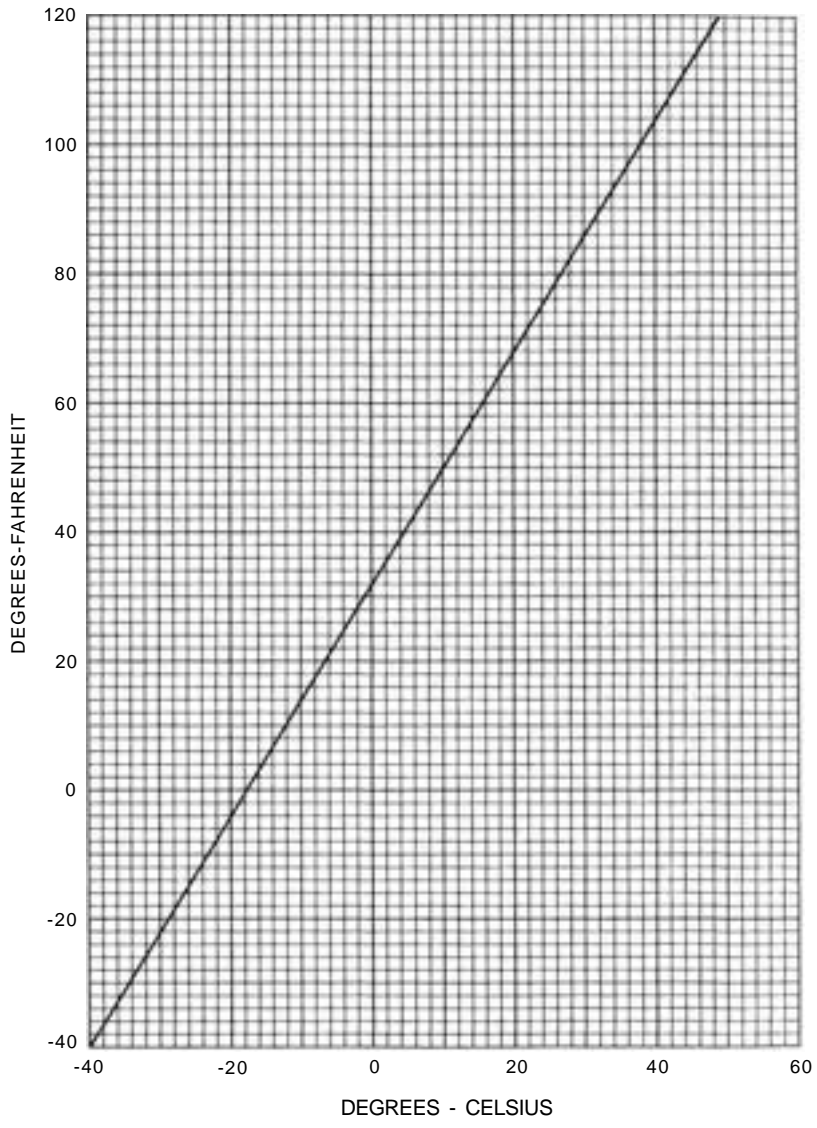

Figure 5-2. Temperature Conversion Chart

## STALL SPEEDS

CONDITION:  
Power Off

NOTE:  
KIAS values are approximate.

### MOST REARWARD CENTER OF GRAVITY

WEIGHT LBS	FLAP DEFLECTION	ANGLE OF BANK							
		0°		30°		45°		60°	
		KIAS	KCAS	KIAS	KCAS	KIAS	KCAS	KIAS	KCAS
1600	UP	46	48	49	52	55	57	65	68
	10°	44	45	47	48	52	54	62	64
	40°	42	42	45	45	50	50	59	59

### MOST FORWARD CENTER OF GRAVITY

WEIGHT LBS	FLAP DEFLECTION	ANGLE OF BANK							
		0°		30°		45°		60°	
		KIAS	KCAS	KIAS	KCAS	KIAS	KCAS	KIAS	KCAS
1600	UP	47	49	51	53	56	58	66	69
	10°	45	46	48	49	54	55	64	65
	40°	42	42	45	45	50	50	59	59

Figure 5-3. Stall Speeds

# TAKEOFF DISTANCE

## SHORT FIELD

**CONDITIONS:**

- Flaps Up
- Full Throttle Prior to Brake Release
- Paved, Level, Dry Runway
- Zero Wind

**NOTES:**

1. Short field technique as specified in Section 4.
2. Prior to takeoff from fields above 5000 feet elevation, the mixture should be leaned to give maximum RPM in a full throttle, static runup.
3. Decrease distances 10% for each 9 knots headwind. For operation with tailwinds up to 10 knots, increase distances by 10% for each 2 knots.
4. Where distance value has been deleted, climb performance after lift-off is less than 150 fpm at takeoff speed.
5. For operation on a dry, grass runway, increase distances by 15% of the "ground roll" figure.

WEIGHT LBS	TAKEOFF SPEED		PRESS ALT FT	0°C			10°C			20°C			30°C			40°C		
	LIFT AT OFF	50 FT		GRND ROLL	TO CLEAR 50 FT	TOTAL OBS	GRND ROLL	TO CLEAR 50 FT	TOTAL OBS	GRND ROLL	TO CLEAR 50 FT	TOTAL OBS	GRND ROLL	TO CLEAR 50 FT	TOTAL OBS	GRND ROLL	TO CLEAR 50 FT	TOTAL OBS
1600	53	60	S.L	655	1245	710	1335	765	1435	820	1540	880	1650					
			1000	720	1365	775	1465	835	1575	900	1690	970	1815					
	2000	790	1500	855	1615	920	1735	990	1865	1065	2005							
	3000	870	1650	935	1780	1010	1915	1090	2065	1170	2225							
	4000	955	1820	1030	1965	1115	2125	1200	2290	1290	2475							
	5000	1050	2015	1140	2185	1230	2360	1325	2555	1430	2770							
	6000	1160	2245	1255	2435	1360	2640	1465	2870	1580	3120							
	7000	1285	2510	1390	2730	1505	2970	1625	3240	1770	3510							
8000	1420	2820	1540	3080	1670	3370	1825	3700	1970	4000								

Figure 5-4. Takeoff Distance

## RATE OF CLIMB

**MAXIMUM**

CONDITIONS:  
Flaps Up  
Full Throttle

WEIGHT LBS	PRESS ALT FT	CLIMB SPEED KIAS	RATE OF CLIMB - FPM			
			-20°C	0°C	20°C	40°C
1600	S.L.	68	770	710	655	595
	2000	67	675	615	560	500
	4000	65	580	520	465	405
	6000	64	485	430	375	310
	8000	63	390	335	280	215
	10,000	62	295	240	185	
	12,000	61	200	150		

Figure 5-5. Rate of Climb



## TIME, FUEL, AND DISTANCE TO CLIMB

### MAXIMUM RATE OF CLIMB

**CONDITIONS:**

Flaps Up  
Full Throttle  
Standard Temperature

**NOTES:**

1. Add 0.8 of a gallon of fuel for engine start, taxi and takeoff allowance.
2. Increase time, fuel and distance by 10% for each 8°C above standard temperature.
3. Distances shown are based on zero wind.

WEIGHT LBS	PRESSURE ALTITUDE FT	TEMP °C	CLIMB SPEED KIAS	RATE OF CLIMB FPM	FROM SEA LEVEL		
					TIME MIN	FUEL USED GALLONS	DISTANCE NM
1600	S.L.	15	68	670	0	0	0
	1000	13	68	630	2	0.2	2
	2000	11	67	590	3	0.5	4
	3000	9	66	550	5	0.7	6
	4000	7	65	510	7	1.0	8
	5000	5	65	470	9	1.3	10
	6000	3	64	425	11	1.6	13
	7000	1	64	385	14	1.9	16
	8000	-1	63	345	17	2.3	19
	9000	-3	63	305	20	2.7	23
	10,000	-5	62	265	23	3.2	27
	11,000	-7	62	220	27	3.7	32
12,000	-9	61	180	33	4.3	38	

Figure 5-6. Time, Fuel, and Distance to Climb

**CRUISE PERFORMANCE**

CONDITIONS:  
1600 Pounds  
Recommended Lean Mixture

PRESSURE ALTITUDE	RDM ft M	20°C BELOW STANDARD TEMP			STANDARD TEMPERATURE			20°C ABOVE STANDARD TEMP		
		% BHP	KTAS	GPH	% BHP	KTAS	GPH	% BHP	KTAS	GPH
2000	2650	---	---	---	78	103	5.9	72	102	5.4
	2600	80	102	6.0	73	101	5.5	68	100	5.1
	2500	70	97	5.3	65	96	4.9	60	95	4.6
	2400	62	92	4.7	57	91	4.3	53	91	4.1
	2300	54	87	4.1	50	87	3.9	47	86	3.7
	2200	47	83	3.7	44	82	3.5	42	81	3.3
4000	2700	---	---	---	78	105	5.8	72	104	5.4
	2600	75	101	5.6	69	100	5.2	64	99	4.8
	2500	66	96	5.0	61	95	4.6	57	95	4.3
	2400	58	91	4.4	54	91	4.1	50	90	3.9
	2300	51	87	3.9	48	86	3.7	45	85	3.5
	2200	45	82	3.5	42	81	3.3	40	80	3.2
6000	2750	---	---	---	77	107	5.8	71	105	5.3
	2700	79	105	5.9	73	104	5.4	67	103	5.1
	2600	70	100	5.2	64	99	4.8	60	98	4.5
	2500	62	95	4.7	57	95	4.3	53	94	4.1
	2400	54	91	4.2	51	90	3.9	48	89	3.7
	2300	48	86	3.7	45	85	3.5	42	84	3.4
8000	2700	74	104	5.5	68	103	5.1	63	102	4.8
	2600	65	99	4.9	60	99	4.6	57	98	4.3
	2500	58	95	4.4	54	94	4.1	51	93	3.9
	2400	52	90	4.0	48	89	3.7	45	88	3.5
	2300	46	85	3.6	43	84	3.4	40	82	3.2
10000	2700	69	103	5.2	64	102	4.8	59	102	4.5
	2600	61	99	4.6	57	98	4.3	53	97	4.1
	2500	55	94	4.2	51	93	3.9	48	92	3.7
	2400	49	89	3.8	45	88	3.6	43	87	3.4
12000	2650	61	100	4.6	57	99	4.3	53	98	4.1
	2600	58	98	4.4	54	97	4.1	50	96	3.9
	2500	52	93	4.0	48	92	3.7	45	91	3.5
	2400	46	89	3.6	43	87	3.4	41	84	3.3

Figure 5-7. Cruise Performance

## RANGE PROFILE

### 45 MINUTES RESERVE 22.5 GALLONS USABLE FUEL

**CONDITIONS:**

1600 Pounds  
Recommended Lean Mixture for Cruise  
Standard Temperature  
Zero Wind

**NOTES:**

1. This chart allows for the fuel used for engine start, taxi, takeoff and climb, and the distance during climb as shown in figure 5-6.
2. Reserve fuel is based on 45 minutes at 45% BHP and is 2.6 gallons.

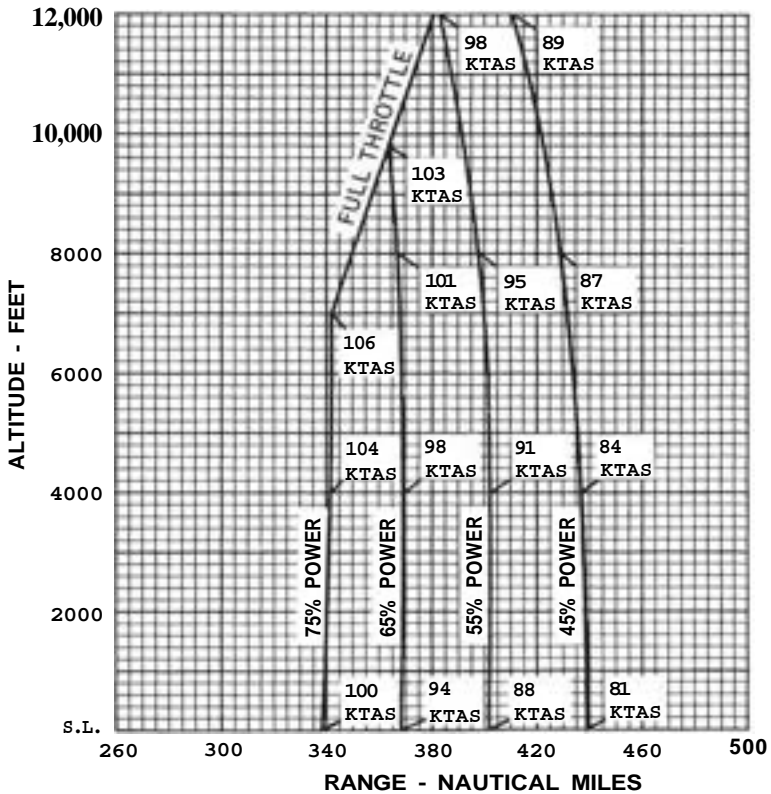

Figure 5-8. Range Profile (Sheet 1 of 2)

## RANGE PROFILE

### 45 MINUTES RESERVE 35.0 GALLONS USABLE FUEL

**CONDITIONS:**

1600 Pounds  
Recommended Lean Mixture for Cruise  
Standard Temperature  
Zero Wind

**NOTES:**

1. This chart allows for the fuel used for engine start, taxi, takeoff and climb, and the distance during climb as shown in figure 5-6.
2. Reserve fuel is based on 45 minutes at 45% BHP and is 2.6 gallons.

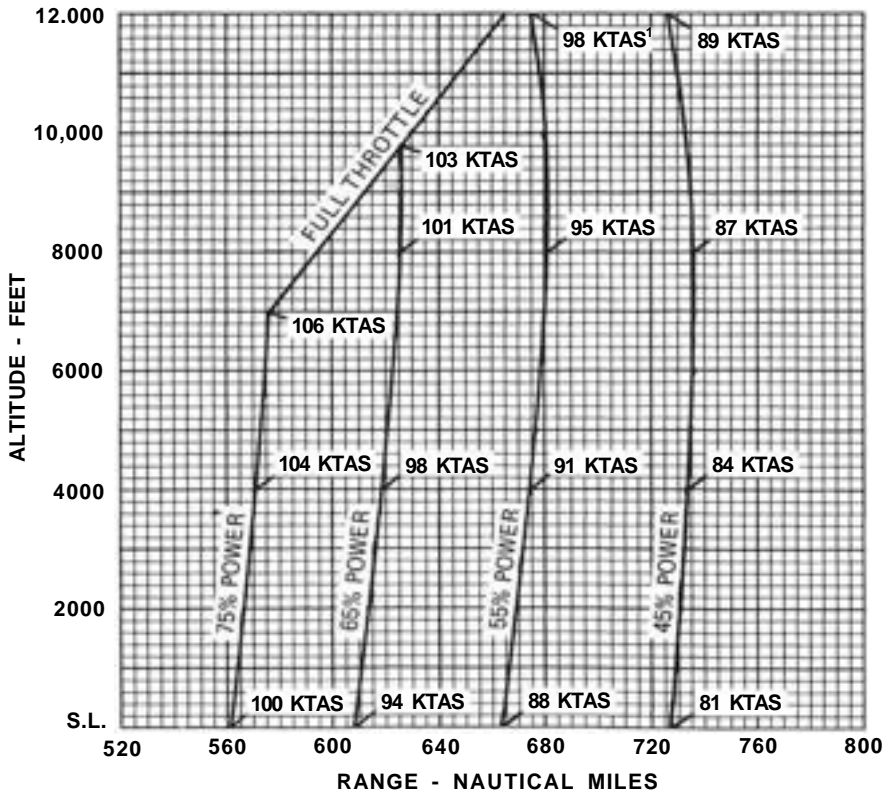

Figure 5-8. Range Profile (Sheet 2 of 2)

### ENDURANCE PROFILE 45 MINUTES RESERVE 22.5 GALLONS USABLE FUEL

CONDITIONS:  
1600 Pounds  
Recommended Lean Mixture for Cruise  
Standard Temperature

- NOTES:
1. This chart allows for the fuel used for engine start, taxi, takeoff and climb, and the time during climb as shown in figure 5-6.
  2. Reserve fuel is based on 45 minutes at 45% BHP and is 2.6 gallons.

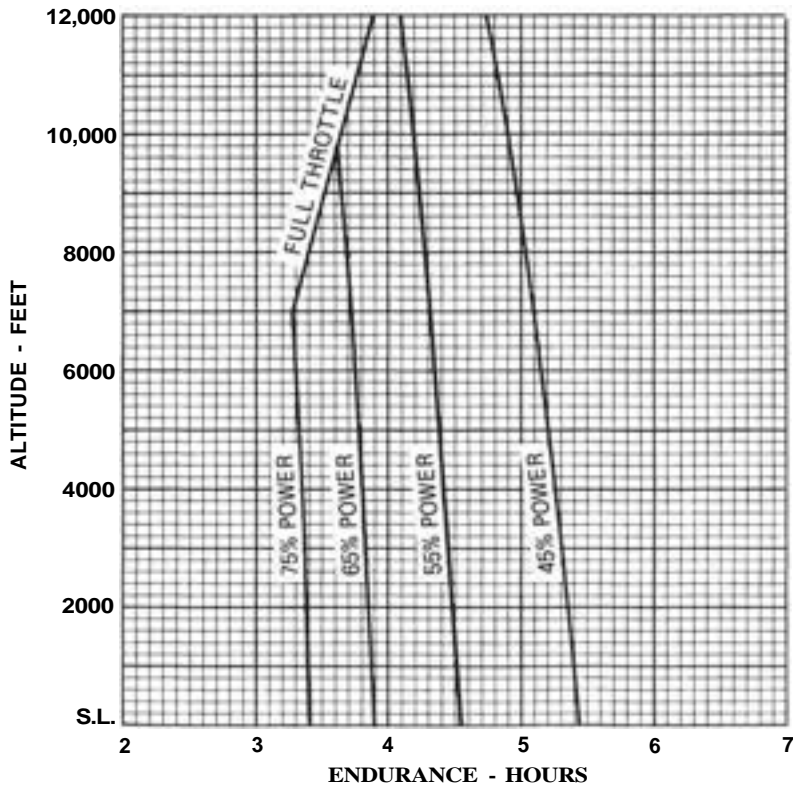

Figure 5-9. Endurance Profile (Sheet 1 of 2)

## ENDURANCE PROFILE

45 MINUTES RESERVE  
35.0 GALLONS USABLE FUEL

CONDITIONS:

1600 Pounds  
Recommended Lean Mixture for Cruise  
Standard Temperature

NOTES:

1. This chart allows for the fuel used for engine start, taxi, takeoff and climb, and the time during climb as shown in figure 5-6.
2. Reserve fuel is based on 45 minutes at 45% BHP and is 2.6 gallons.

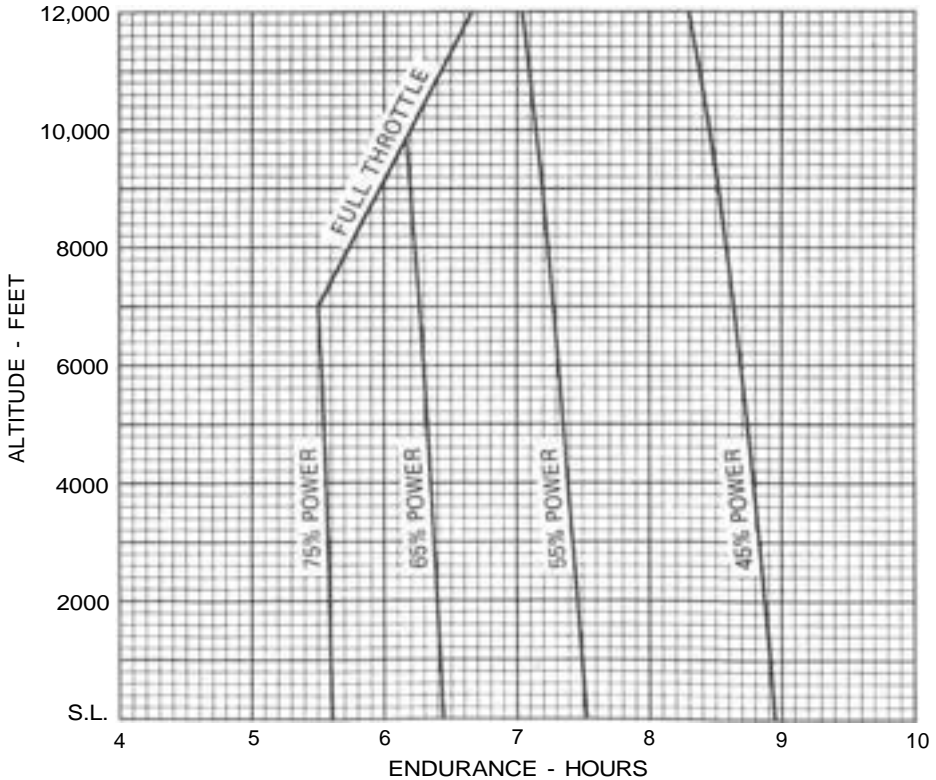

Figure 5-9. Endurance Profile (Sheet 2 of 2)

# LANDING DISTANCE

## SHORT FIELD

CONDITIONS:  
Flaps 40°  
Power Off  
Maximum Braking  
Paved, Level, Dry Runway  
Zero Wind

NOTES:

1. Short field technique as specified in Section 4.
2. Decrease distances 10% for each 9 knots headwind. For operation with tailwinds up to 10 knots, increase distances by 10% for each 2 knots.
3. For operation on a dry, grass runway, increase distances by 45% of the "ground roll" figure.

WEIGHT LBS	SPEED AT 50 FT KIAS	PRESS ALT FT	0°C			10°C			20°C			30°C			40°C			
			GRND ROLL	TO CLEAR 50 FT OBS	TOTAL	GRND ROLL	TO CLEAR 50 FT OBS	TOTAL	GRND ROLL	TO CLEAR 50 FT OBS	TOTAL	GRND ROLL	TO CLEAR 50 FT OBS	TOTAL	GRND ROLL	TO CLEAR 50 FT OBS	TOTAL	
1600	52	S.L.	425	1045	440	1065	455	1090	470	1110	485	1135	490	1140	490	1145	490	1150
		1000	440	1065	455	1090	470	1115	485	1135	495	1160	505	1185	510	1200	510	1210
		2000	455	1090	470	1115	485	1140	500	1165	510	1190	520	1215	530	1240	540	1265
		3000	470	1115	490	1140	505	1165	520	1190	535	1215	550	1240	565	1265	580	1290
		4000	490	1140	505	1165	520	1190	540	1215	560	1240	585	1265	610	1290	630	1315
		5000	510	1170	525	1195	545	1220	565	1245	585	1265	605	1285	625	1305	645	1325
		6000	530	1200	545	1225	565	1250	585	1270	605	1290	620	1310	640	1330	655	1345
		7000	550	1230	570	1260	590	1290	610	1320	630	1350	650	1380	670	1400	685	1415
8000	570	1260	590	1290	610	1320	630	1350	650	1380	670	1410	690	1440	705	1455		

Figure 5-10. Landing Distance





# SECTION 6 WEIGHT & BALANCE/ EQUIPMENT LIST

## TABLE OF CONTENTS

	Page
Introduction . . . . .	6-3
Airplane Weighing Procedures . . . . .	6-3
Weight and Balance . . . . .	6-6
Equipment List . . . . .	6-13



## INTRODUCTION

This section describes the procedure for establishing the basic empty weight and moment of the airplane. Sample forms are provided for reference. Procedures for calculating the weight and moment for various operations are also provided. A comprehensive list of all Cessna equipment available for this airplane is included at the back of this section.

It should be noted that specific information regarding the weight, arm, moment and installed equipment list for this airplane can only be found in the appropriate weight and balance records carried in the airplane.

## AIRPLANE WEIGHING PROCEDURES

- (1) Preparation:
  - a. Inflate tires to recommended operating pressures.
  - b. Remove the fuel tank sump quick-drain fittings and fuel line drain plug to drain all fuel.
  - c. Remove oil sump drain plug to drain all oil.
  - d. Move sliding seats to the most forward position.
  - e. Raise flaps to the fully retracted position.
- (2) Leveling:
  - a. Place scales under each wheel (500# minimum capacity for scales).
  - b. Deflate nose tire and/or lower or raise the nose strut to center bubble on level (see Figure 6-1).
- (3) Weighing:
  - a. With the airplane level and brakes released, record the weight shown on each scale. Deduct the tare, if any, from each reading.
- (4) Measuring:
  - a. Obtain measurement A by measuring horizontally (along the airplane center line) from a line stretched between the main wheel centers to a plumb bob dropped from the firewall.
  - b. Obtain measurement B by measuring horizontally and parallel to the airplane center line, from center of nose wheel axle, left side, to a plumb bob dropped from the line between the main wheel centers. Repeat on right side and average the measurements.
- (5) Using weights from (3) and measurements from (4) the airplane weight and C. G. can be determined.

SECTION 6  
WEIGHT & BALANCE/  
EQUIPMENT LIST

CESSNA  
MODEL 150M

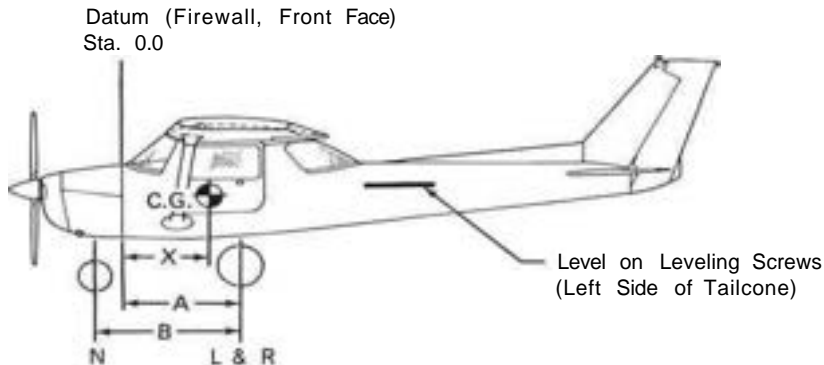

Scale Position	Scale Reading	Tare	Symbol	Net Weight
Left Wheel			L	
Right Wheel			R	
Nose Wheel			N	
Sum of Net Weights (As Weighed)			W	

$$X = \text{ARM} = \frac{(A) \cdot (N) + (B) \cdot (W)}{(W)} ; X = ( \quad ) - \frac{( \quad ) \cdot ( \quad )}{( \quad )} = ( \quad ) \text{ IN.}$$

Item	Weight (Lbs.)	X C.G. Arm (In.)	Moment/1000 (Lbs.-In.)
Airplane Weight (From Item 5, page 6-3)			
Add Oil:			
No Oil Filter (6 Qts at 7.5 Lbs/Gal)		-13.5	
With Oil Filter (7 Qts at 7.5 Lbs/Gal)		-13.5	
Add Unusable Fuel:			
Std. Tanks (3.5 Gal at 6 Lbs/Gal)		40.0	
L.R. Tanks (3.0 Gal at 6 Lbs/Gal)		40.0	
Equipment Changes			
Airplane Basic Empty Weight			

Figure 6-1. Sample Airplane Weighing



- (6) Basic Empty Weight may be determined by completing Figure 6-1.

## WEIGHT AND BALANCE

The following information will enable you to operate your Cessna within the prescribed weight and center of gravity limitations. To figure weight and balance, use the Sample Problem, Loading Graph, and Center of Gravity Moment Envelope as follows:

Take the basic empty weight and moment from appropriate weight and balance records carried in your airplane, and enter them in the column titled YOUR AIRPLANE on the Sample Loading Problem.

### NOTE

In addition to the basic empty weight and moment noted on these records, the c. g. arm (fuselage station) is also shown, but need not be used on the Sample Loading Problem. The moment which is shown must be divided by 1000 and this value used as the moment/1000 on the loading problem.

Use the Loading Graph to determine the moment/1000 for each additional item to be carried; then list these on the loading problem.

### NOTE

Loading Graph information for the pilot, passengers and baggage is based on seats positioned for average occupants and baggage loaded in the center of the baggage areas as shown on the Loading Arrangements diagram. For loadings which may differ from these, the Sample Loading Problem lists fuselage stations for these items to indicate their forward and aft c. g. range limitation (seat travel and baggage area limitation). Additional moment calculations, based on the actual weight and c. g. arm (fuselage station) of the item being loaded, must be made if the position of the load is different from that shown on the Loading Graph.

Total the weights and moments /1000 and plot these values on the Center of Gravity Moment Envelope to determine whether the point falls within the envelope, and if the loading is acceptable.

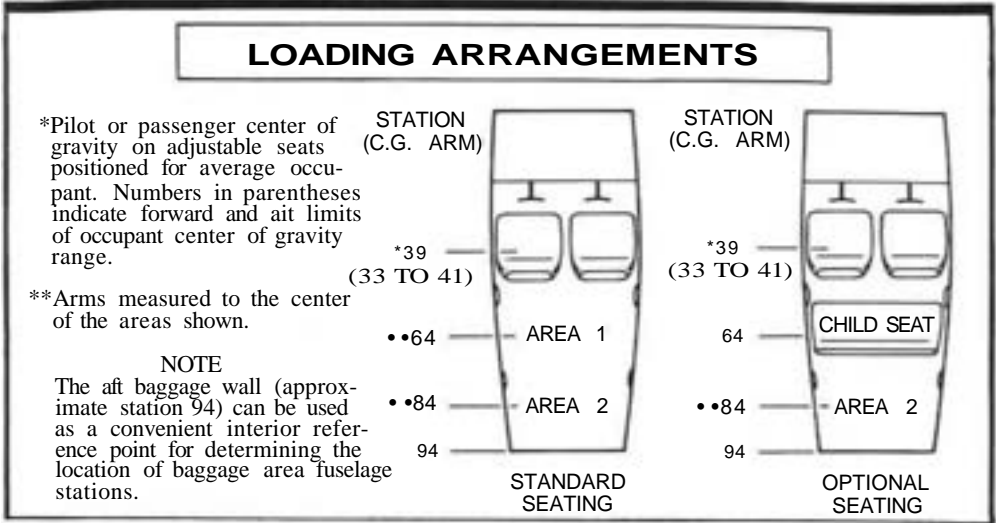

Figure 6-3. Loading Arrangements

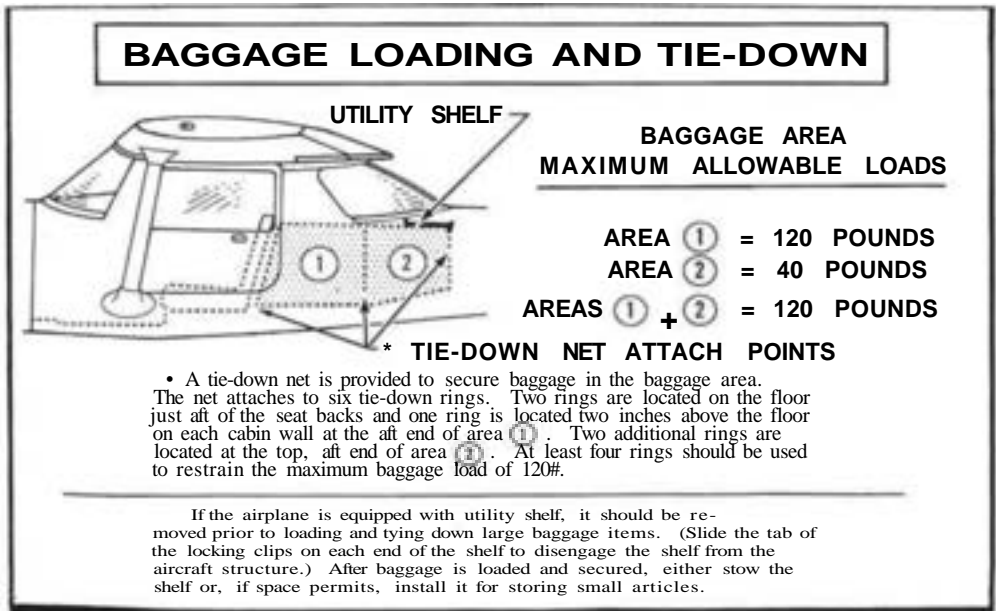
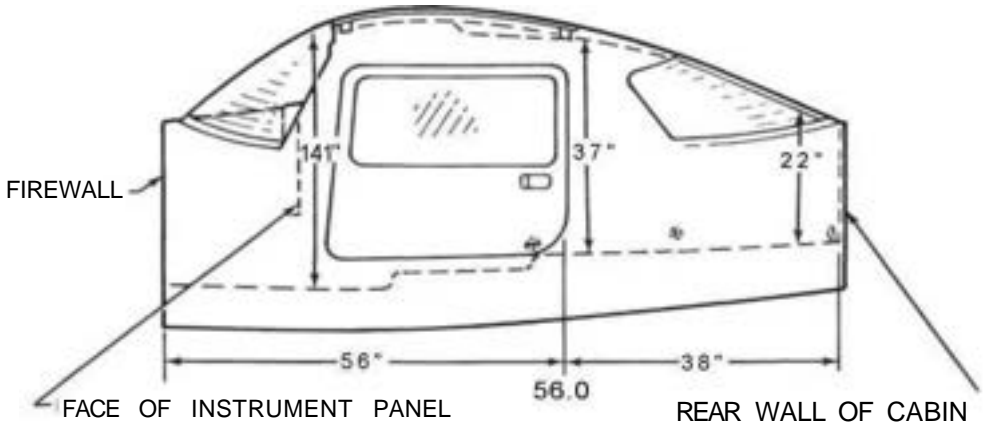

Figure 6-4. Baggage Loading and Tie-Down

**CABIN HEIGHT MEASUREMENTS**



FACE OF INSTRUMENT PANEL

REAR WALL OF CABIN

**DOOR OPENING DIMENSIONS**

WIDTH (TOP)	WIDTH (BOTTOM)	HEIGHT (FRONT)	HEIGHT (REAR)
31"	3 31/4"	31 1/2"	31"

- \* WIDTH —
- LWR WINDOW LINE
  - \* CABIN FLOOR

**CABIN WIDTH MEASUREMENTS**

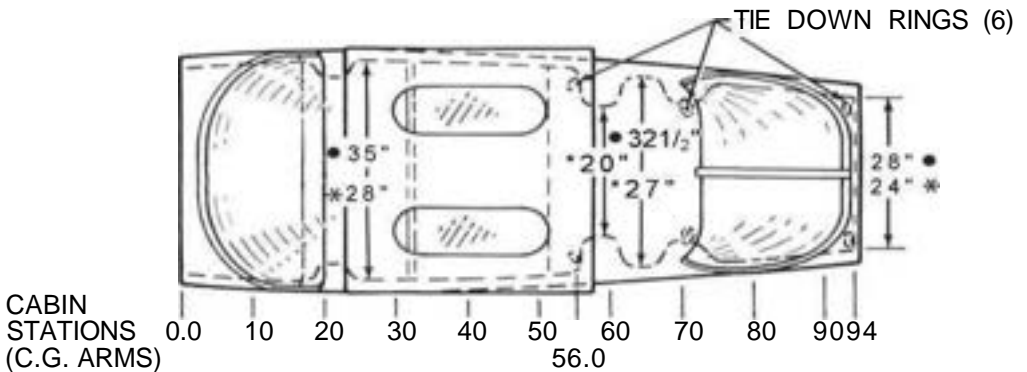

Figure 6-5. Internal Cabin Dimensions



SAMPLE AIRPLANE	YOUR AIRPLANE	
	Weight (lbs.)	Moment (lb.-ins. /1000)
<p style="text-align: center;"><b>SAMPLE LOADING PROBLEM</b></p> <p>1. Basic Empty Weight (Use the data pertaining to your airplane as it is presently equipped. Includes unusable fuel and full oil) . . . . .</p> <p>2. Usable Fuel (At 6 Lbs./Gal.) Standard Tanks (22.5 Gal. Maximum) . . . . .</p> <p>Long Range Tanks (35 Gal. Maximum) . . . . .</p> <p>Reduced Fuel (As limited by maximum weight) . . . . .</p> <p>3. Pilot and Passenger (Station 33 to 41) . . . . .</p> <p>4. Baggage - Area 1 (Or passenger on child's seat) (Station 50 to 76, 120 Lbs. Max.) . . . . .</p> <p>5. Baggage - Area 2 (Station 76 to 94, 40 Lbs. Max.) . . . . .</p> <p>6. TOTAL WEIGHT AND MOMENT</p> <p>7. Locate this point (1600 at 55.6) on the Center of Gravity Moment Envelope, and since this point falls within the envelope, the loading is acceptable.</p>	1125	36.6
	135	5.7
	340	13.3
	1600	55.6

Figure 6-6. Sample Loading Problem

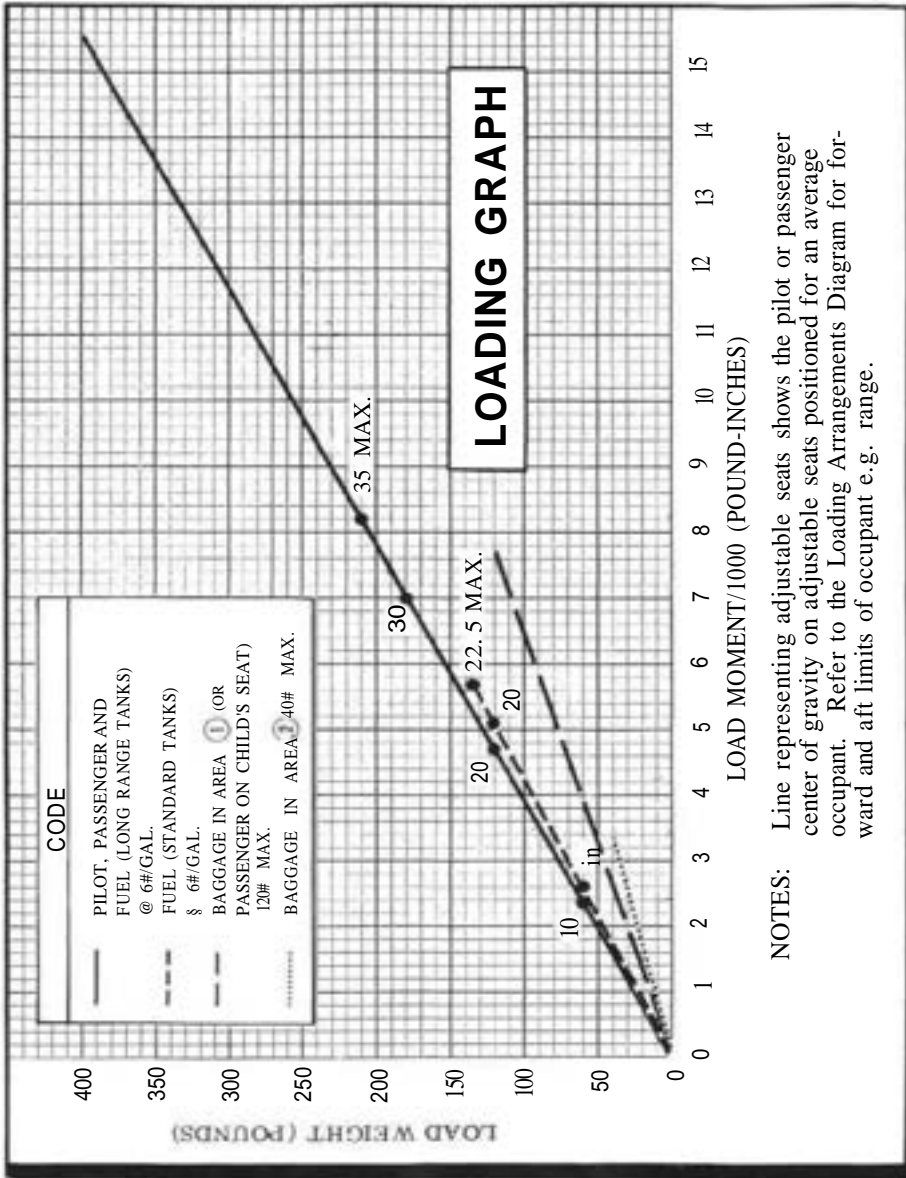

Figure 6-7. Loading Graph

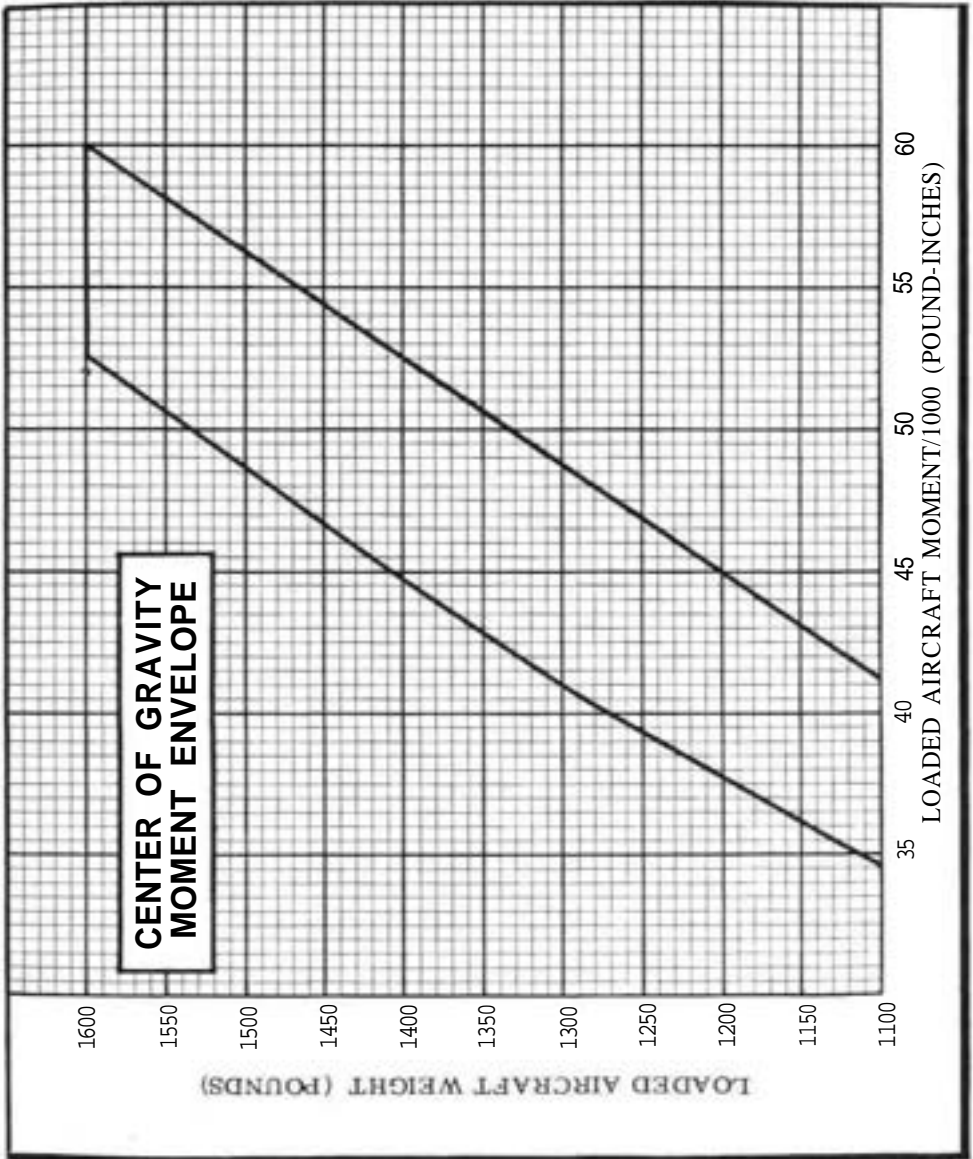

Figure 6-8. Center of Gravity Moment Envelope

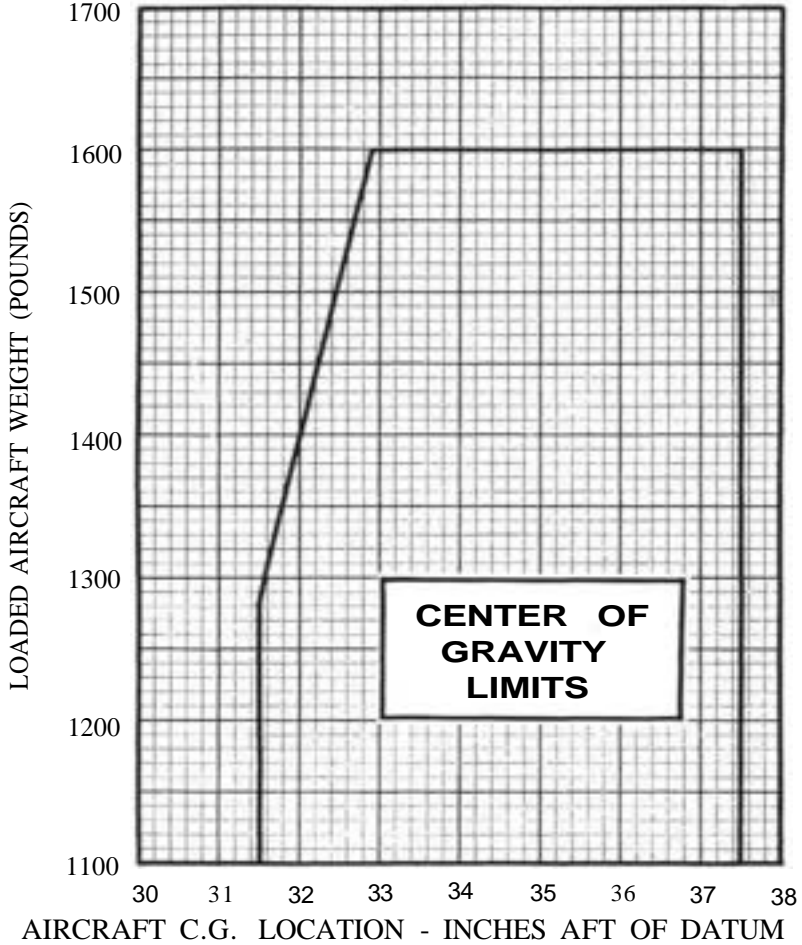

Figure 6-9. Center of Gravity Limits

## EQUIPMENT LIST

The following equipment list is a comprehensive list of all Cessna equipment available for this airplane. A separate equipment list of items installed in your specific airplane is provided in your aircraft file. The following list and the specific list for your airplane have a similar order of listing.

This equipment list provides the following information:

An item number gives the identification number for the item. Each number is prefixed with a letter which identifies the descriptive grouping (example: A. Powerplant & Accessories) under which it is listed. Suffix letters identify the equipment as a required item, a standard item or an optional item. Suffix letters are as follows:

- R = required items of equipment for FAA certification
- S = standard equipment items
- O = optional equipment items replacing required or standard items
- A = optional equipment items which are in addition to required or standard items

A reference drawing column provides the drawing number for the item.

### NOTE

If additional equipment is to be installed, it must be done in accordance with the reference drawing, accessory kit instructions, or a separate FAA approval.

Columns showing weight (in pounds) and arm (in inches) provide the weight and center of gravity location for the equipment.

### NOTE

Unless otherwise indicated, true values (not net change values) for the weight and arm are shown. Positive arms are distances aft of the airplane datum; negative arms are distances forward of the datum.

### NOTE

Asterisks (\*) after the item weight and arm indicate complete assembly installations. Some major components of the assembly are listed on the lines immediately following. The summation of these major components does not necessarily equal the complete assembly installation.

SECTION 6  
WEIGHT & BALANCE/  
EQUIPMENT LIST

CESSNA  
MODEL 150M

ITEM NO	EQUIPMENT LIST DESCRIPTION	REF DRAWING	WT LBS	ARM INS
	A. POWERPLANT & ACCESSORIES			
A01-R	ENGINE* CONTINENTAL O-200-A (INCLUDES ELECTRICALLY ENGAGING STARTER)	0450500	210.5	-17.5
A05-R	FILTER, CARBURETOR AIR (AIR MAZE)	121614	0.5	-24.5
A09-R	ALTERNATOR, 60-AMP, 14 VCLT (GEAR DRIVE)	C611501-0233	11.5	-6.5
A17-A	OIL COOLER, INSTALLATION	0401020	2.5*	-6.5*
A21-A	FILTER, INSTALLATION, FULL FLOW ENGINE OIL ADAPTER ASSEMBLY	0450405-2	4.5*	-8.0*
	FILTER ELEMENT KIT	0450404-3	1.1	-5.7
A33-R	PROPELLER INSTALLATION	C294505-0102	0.3	-34.4*
	PROPELLER MCCAULEY FIXED PITCH	C161001-0403	27.2*	-35.0
	3.06 INCH PROP SPACER ADAPTER MCCAULEY	1A102/OCM6948	20.6	-32.1
A41-S	SPINNER, PROPELLER	C-4513	4.4*	-37.0*
	SPINNER DOME	0450051	1.5*	-36.0*
	ALT SPINNER BULKHEAD	0450042-1	0.8	-37.8
	FORWARD SPINNER BULKHEAD	00450046-3	0.3	-34.6
A61-S	VACUUM SYSTEM INSTALLATION, ENGINE DRIVEN DRY VACUUM PUMP	0450050-1	5.3*	-11.7*
	FILTER ASSEMBLY	0413466-1	5.3*	-11.7*
	VACUUM GAUGE	C431003	2.8	-26.4
	VACUUM RELIEF VALVE, AIRBORNE 133A14	C294502 0201	0.5	2.0
A73-A	VALVE, ENGINE OIL QUICK DRAIN (NET CHANGE)	C68509-0101	0.1	18.0
		C482001-0401	0.5	1.9
		1701015-4	0.0	-
	B. LANDING GEAR S ACCESSORIES			
	WHEEL, BRAKE & TIRE ASSY, 6.00-6 MAIN (2)	C163016-0127	38.5*	46.8*
	WHEEL ASSEMBLY, MCCAULEY (EACH)	C163 4-- 1.4	6.4	47.1
	BRAKE ASSEMBLY, MCCAULEY (LEFT)	C163032-0109	1.8	43.7
	BRAKE ASSEMBLY, MCCAULEY (RIGHT)	C163032-0108	1.8	43.7
	TIRE, V-PLY BLACKWALL (EACH)	C262003-0101	8.5	47.1
	TUBE, (EACH)	C262023-0102	1.8	47.1
B04-R	WHEEL'S, TIRE ASSY 5*00-5 NCSE	C163018-0101	18.7*	-10.8*
	WHEEL ASSY, MCCAULEY	C163005-0201	2.4	-10.8
	TPE, 4-PLY, 8 LACKWALL (FACH)	C262003-0102	4.0	-10.8

ITEM NO	EQUIPMENT LIST DESCRIPTION	REF DRAWING	WT LBS	ARM INS
B10-R	TUBE (EACH) WHEEL FAIRINGS (SET OF 3) NOSE WHEEL FAIRING MAIN WHEEL FAIRING (EACH) BRAKE FAIRINGS (EACH)	C262023-0101 0541225 00543079 00541223 0441227	1.2 18.0* 4.1 5.9 0.6	-10.8 35.3* -9.5 49.5 50.5
C. ELECTRICAL SYSTEM				
C01-R	BATTERY, 12-VOLT, 24-AMP HOUR	0511319	23.0	-4.5
C04-R	REGULATOR, ALTERNATOR 60-AMP, 14 VOLT	C611001-0201	0.6	-1.0
C07-A	GROUND SERVICE RECEPTACLE	0470009	2.0	-2.0
C16-S	PITOT HEATER	0422355	0.6	21.5
C23-A	LIGHT INSTALLATION, CONTROL WHEEL MAP	0470117-3	0.2	22.5
C43-S	LIGHT INSTALLATION, OMNIFLASH BEACON BEACON LIGHT IN FIN TIP	0406003-1 C621001-0106	1.4* 0.4	185.5* 210.9
C46-A	FLASHER POWER SUPPLY IN AFT TAILCONE RESISTOR (MEMCOR) LIGHT INSTALLATION WING TIP STROBE STROBE LIGHTS IN WING TIP (SET OF 2) FLASHER POWER SUPPLIES IN TIPS (SET OF 2)	C594502-0101 0R9 5-1.5 0401009-1 C622006-0131 C622007-0101	0.5 0.2 3.1* 0.2 2.3	173.9 183.4 37.8* 35.5 39.5
C49-S C49-0	LIGHT INSTALLATION, COWL MOUNTED LANDING LIGHT INSTALLATION, COWL MOUNTED, DUAL	0401014 0401010	1.4 2.0	-21.9 -33.1
D. INSTRUMENTS				
D01-R	INDICATOR, AIRSPEED	C661064-0101	0.6	17.2
D07-R	INDICATOR, TRUE AIRSPEED	0513279	1.0	18.0
007-0-1	ALTIMETER, SENSITIVE	C661071-0101	1.0	17.6
007-0-2	ALTIMETER, SENSITIVE (20 FT MARKINGS) (FEET AND MILLIBARS) ALTIMETER, SENSITIVE (50 FT. MARKINGS) (FEET AND MILLIBARS)	C661025-0102 C 661071-0102	1.0 1.0	17.6 17.6
016-A-1	ENCODING ALTIMETER (INCLUDES RELOCATION OF CONVENTIONAL ALTIMETER)	0401013	2.9	17.0
D16-A-2	ENCODING ALTIMETER (FEET & MILLIBARS (INCLUDES RELOCATION OF CONVENTIONAL	0401013	2.9	17.0

SECTION 6  
WEIGHT & BALANCE/  
EQUIPMENT LIST

CESSNA  
MODEL 150M

ITEM NO	EQUIPMENT LIST DESCRIPTION	REF DRAWING	WT LBS	ARM INS
D16-A-3	ALTIMETER) ENCODING ALTIMETER, USE WITH TRANSPONDER (BLIND ENCODER-DOES NOT REQUIRE PANEL MOUNT)	0401019	1.5	2.0
025-S	AMMETER CLOCK INSTALLATION CLOCK ELECTRIC	S-1320-5 0400523-1	0.5 0.4*	18.0
D28-R	COMPASS	C664508-0101	0.3	18.1
037-R	INSTRUMENT CLUSTER (LH FUEL & RH *UEL)	C660501-0101	0.5	20.0
040-R	INSTRUMENT CLUSTER (OIL PRES. & OIL TEMP.)	C669511-0101	0.6	18.0
064-S	GYRO INSTALLATION (REQUIRES ITEM A61-S VACUUM SYSTEM)	C669512-0103 0413466-1	0.6 7.1*	18.0 14.8*
D64-0	DIRECTIONAL INDICATOR ATTITUDE INDICATOR HOSES, FITTINGS, SCREWS GYRO INSTALLATION, DIRECTIONAL INDICATOR WITH MOVABLE HEADING POINTER DIRECTIONAL INDICATOR ATTITUDE INDICATOR HOSES, FITTINGS, SCREWS RECORDER* ENGINE HOUR METER OUTSIDE AIR TEMPERATURE GAGE TACHOMETER INSTALLATION, ENGINE RECORDING TACH INDICATOR TACH FLEXIBLE SHAFT INDICATOR, TURN COORDINATOR INDICATOR, TURN & BANK RATE OF CLIMB INDICATOR	C661075 C661076 0413466	2.8 2.1 1.4 7.4*	15.6 15.8 9.0 14.8*
067-A	DIRECTIONAL INDICATOR	1201126	3.1	15.8
D82-S	HOSES, FITTINGS, SCREWS	C661076	2.1	15.8
085-R	RECORDER* ENGINE HOUR METER	0413466	1.4	9.0
088-S	OUTSIDE AIR TEMPERATURE GAGE	0401017	0.6	7.8
D88-0	TACHOMETER INSTALLATION, ENGINE	C668507-0101	0.1	22.0*
D91-S	RECORDING TACH INDICATOR	1.0*	1.0	12.5*
	TACH FLEXIBLE SHAFT	C668020-0113	0.6	17.0
	INDICATOR, TURN COORDINATOR	S-1605-3	0.3	2.0
	INDICATOR, TURN & BANK	C661003-0504	1.3	17.2
	RATE OF CLIMB INDICATOR	S-1413N2 C 661080-0101	2.0 1.1	16.5 18.0
E05-R	E. CABIN ACCOMMODATIONS			
E05-0	SEAT, PILOT INDIVIDUAL SLIDING	0414060	11.1	45.2
E07-S	SEAT, VERTICALLY ADJUSTABLE, PILOT	0414056	13.6	45.2
E07-0	SEAT, CO-PILOT INDIVIDUAL SLIDING	0414060	11.1	45.2*
EC9-A	SEAT, VERTICALLY ADJUSTABLE, CO-PILOT	0414056	13.6	45.2*
	SEAT INSTALLATION, AUXILIARY	0400134-1	10.5*	66.5*
	UPPER BACK REST CUSHION	0711080-1	1.3	72.9
	LOWER SEAT CUSHION ASSEMBLY	0400136-9	6.4	66.0
	LAP BELT ASSEMBLY	S-1746-2	1.0	66.0



ITEM NO	EQUIPMENT LIST DESCRIPTION	REF DRAWING	WTLBS	ARM INS
E15-R	BELT ASSY, PILOT LAP	S-2275-104	1.0	39.0
E15-S	SHOULDER HARNESS ASSY, PILOT	S-2275-202	1.0	39.0
	SHOULDER HARNESS INERTIA INSTL., PILOT & CO-PILOT (NET CHANGE)	0401012-1	1.3	71.1
E23-S	BELT & SHOULDER HARNESS ASSY CO-PILOT	S-2275-4	2.0	39.0
E23-A	WINDOWS, OVERHEAD CABIN TOP (NET INCREASE)	0413492	0.3	49.0
E23-S	MIRROR, REAR VIEW	0400338	0.3	17.0
E23-S	SUN VISORS (SET OF 2)	0413473-1	0.0	27.0
E57-A	WINDOWS, TINTED (SET OF 4, NET CHANGE)	0400324-1	0.0	-
E61-A	SHELF INSTALLATION, UTILITY	0412070-4	1.0	84.0
E65-S	BAGGAGE NET	2015008-2	0.5	12.1
E65-S	DUAL CONTROLS (WHEEL PEDALS & TOE BRAKES)	0460J18-2	4.1	-21.0
E83-R	HEATING SYSTEM, CABIN & CABURETOR AIR (INCLUDES EXHAUST SYSTEM)	0450500	9.5	-
F01-R	F. PLACARDS 6 WARNING	0405034-3	NEGL	23.0
F04-R	OPERATIONAL LIMITATIONS PLACARD VFR-1FR DAY AND NIGHT INDICATOR, STALL WARNING AUDIBLE	0413029	0.5	21.5
G04-A	G. AUXILIARY EQUIPMENT			
G07-A	HOOK, TOW (INSTALLED)	0500228	5.5	200.0
G13-A	HOISTING RINGS (STOWED)	0541115	2.0	84.0
G16-A	CORROSION PROOFING AIRCRAFT CABIN TOP	0400027-2	4.5	428.0
G19-A	STABILIZER DISCHARGERS (SET OF 10)	0401015	0.5	179.4
G22-S	STABILIZER ABRASION BOOTS	0501019-1	1.9	84.0
G25-S	TOW BAR, AIRCRAFT WHEEL (STOWED) PAINT, OVERALL EXTERIOR OVERALL WHITE BASE OVERALL WHITE BASE COLORED STRIPE	0404027	8.5	79.0
G31-A	CABLES, COPROSION RESISTANT CONTROL (NET CHANGE)	0400027	0.1	7.5
G34-S	LIGHTER, CIGARETTE	0513052-16	9.1	18.0
G55-A	FIRE EXTINGUISHER, HAND TYPE	0401001	3.0	9.5

SECTION 6  
WEIGHT & BALANCE/  
EQUIPMENT LIST

CESSNA  
MODEL 150M

ITEM NO	EQUIPMENT LIST DESCRIPTION	REF DRAWING	WT LBS	ARM IN'S
G58-A	STEPS S HANDLES* REFUELING ASSIST WINTERIZATION KIT INSTALLATION, ENGINE COVER PLATEST FWO COWL (SET OF 2 INSTALLED) COVER PLATES, FORWARD COWL (STOWEO) CRANKCASE BREATHER TUBE INSULATION WINGS WITH 38 GALLON CAPACITY EXTENDED RANGE FUEL TANKS (SET OF 2, NET CHANGE)	0413456-2	2.1	9.9
G88-A		0450105-2	1.2*	-22.0*
		0450409	0.3	-32.0
G92-A		0450409	0.3	84.0
		0456004	0.3	-20.1
		0426008	5.9	37.3
H. AVIONICS £ AUTOPILOTS				
H01-A	CESSNA 300 ADF RECEIVER WITH BFO (R-546E) INDICATOR UN-346A) ANTENNA INSTALLATION LOOP ANTENNA INSTALLATION CABLE INSTALLATION COMPONENTS	3910159-11 41240-0101 40980-1001 0470400-621 3960104-1 3950104-14	7.3* 2.3 0.9 0.2 1.4 1.8	18.2* 13.5 15.5 96.5 24.2 12.3 14.4
H07-A	MISC. INSTALLATION COMPONENTS CESSNA 400 GLIDESLOPE RECEIVER (R-443B) MOUNTING, RIGID ANTENNA	3910157-10 42100-0000 36450-0000 1200098-2 3910142-1 42410-5114	4.0* 2.1 0.3 2.2* 0.8	80.4* 105.3 100.0 20.4 35.4* 11.7
H13-A-1	CESSNA 400 MARKER BEACON RECEIVER (R-402A) ANTENNA, L SHAPED ROD BENDIX MARKER BEACON (EXPORT USE) RECEIVER	0770681-1 3910174-1 GM-247A	0.6 3.9* 1.5	86.0 85.7* 99.8
H13-A-2	RECEIVER	GM-247A	0.6	86.0
H16-A-1	ANTENNA, L SHAPED ROD CESSNA 300, TRANSPONDER TRANSCIEVER (RT-359A)	0770681-1 3910127-1 41420-1114	0.6 3.6* 2.7	86.0 18.6* 13.0
H16-A-2	ANTENNA (A-109B) CESSNA 400 TRANSPONDER (EXPORT USE) TRANSCIEVER (RT-459A) ANTENNA (A-109B)	41530-0001 3910128-20 41470-1114	0.1 3.6* 2.8	67.0 18.6* 13.0
H19-A	CESSNA 300 VHF TRANSCIEVER, 1ST UNIT TRANSCIEVER (RT-524A) NOTE—INSTALLATION COMPONENTS ARE AS LISTED	41530-0001 3910155-13 31390-1814	0.1 11.9 7.1	67.0 18.3 12.9
	VHF ANTENNA £ CABLE INSTALLATION	3960113-1	0.8	41.9

# SECTION 7 AIRPLANE & SYSTEMS DESCRIPTIONS

## TABLE OF CONTENTS

	Page
Introduction . . . . .	7-3
Airframe . . . . .	7-3
Flight Controls . . . . .	7-8
Trim System . . . . .	7-8
Instrument Panel . . . . .	7-8
Ground Control . . . . .	7-9
Wing Flap System . . . . .	7-10
Landing Gear System . . . . .	7-10
Baggage Compartment . . . . .	7-10
Seats . . . . .	7-10
Seat Belts and Shoulder Harnesses . . . . .	7-11
Seat Belts . . . . .	7-11
Shoulder Harnesses . . . . .	7-13
Integrated Seat Belt/Shoulder Harnesses With Inertia Reels . . . . .	7-13
Entrance Doors and Cabin Windows . . . . .	7-14
Control Locks . . . . .	7-14
Engine . . . . .	7-15
Engine Controls . . . . .	7-15
Engine Instruments . . . . .	7-15
New Engine Break-in and Operation . . . . .	7-16
Engine Oil System . . . . .	7-16
Ignition-Starter System . . . . .	7-17
Air Induction System . . . . .	7-17
Exhaust System . . . . .	7-18
Carburetor and Priming System . . . . .	7-18
Cooling System . . . . .	7-18
Propeller . . . . .	7-19
Fuel System . . . . .	7-19
Brake System . . . . .	7-21
Electrical System . . . . .	7-22
Master Switch . . . . .	7-22
Ammeter . . . . .	7-22

**TABLE OF CONTENTS (Continued)**

	Page
Over-Voltage Sensor and Warning Light . . . . .	7-24
Circuit Breakers and Fuses . . . . .	7-24
Ground Service Plug Receptacle . . . . .	7-24
Lighting Systems . . . . .	7-25
Exterior Lighting . . . . .	7-25
Interior Lighting . . . . .	7-25
Cabin Heating, Ventilating and Defrosting System . . . . .	7-26
Pitot-Static System and Instruments . . . . .	7-28
Airspeed Indicator . . . . .	7-28
Rate-of-Climb Indicator . . . . .	7-28
Altimeter . . . . .	7-29
Vacuum System and Instruments . . . . .	7-29
Attitude Indicator . . . . .	7-29
Directional Indicator . . . . .	7-29
Suction Gage . . . . .	7-29
Stall Warning System . . . . .	7-31
Avionics Support Equipment . . . . .	7-31
Audio Control Panel . . . . .	7-31
Static Dischargers . . . . .	7-32

## INTRODUCTION

This section provides description and operation of the airplane and its systems. Some equipment described herein is optional and may not be installed in the airplane. Refer to Section 9, Supplements, for details of other optional systems and equipment.

## AIRFRAME

The construction of the fuselage is a conventional formed sheet metal bulkhead, stringer, and skin design referred to as semi-monocoque. Major items of structure are the front and rear carry-through spars to which the wings are attached, a bulkhead and forgings for main landing gear attachment at the base of the rear door posts, and a bulkhead with attaching plates at the base of the forward door posts for the lower attachment of the wing struts. Four engine mount stringers are also attached to the forward door posts and extend forward to the firewall.

The externally braced wings, containing the fuel tanks, are constructed of a front and rear spar with formed sheet metal ribs, doublers, and stringers. The entire structure is covered with aluminum skin. The front spars are equipped with wing-to-fuselage and wing-to-strut attach fittings. The aft spars are equipped with wing-to-fuselage attach fittings, and are partial-span spars. Conventional hinged ailerons and single-slotted flaps are attached to the trailing edge of the wings. The ailerons are constructed of a forward spar containing a balance weight, formed sheet metal ribs and "V" type corrugated aluminum skin joined together at the trailing edge. The flaps are constructed basically the same as the ailerons, with the exception of balance weight and the addition of a formed sheet metal leading edge section.

The empennage (tail assembly) consists of a conventional vertical stabilizer, rudder, horizontal stabilizer, and elevator. The vertical stabilizer consists of a spar, formed sheet metal ribs and reinforcements, a wrap-around skin panel, formed leading edge skin and a dorsal. The rudder is constructed of a formed leading edge skin containing hinge halves, a wrap-around skin panel and ribs, and a formed trailing edge skin with a ground adjustable trim tab at its base. The top of the rudder incorporates a leading edge extension which contains a balance weight. The horizontal stabilizer is constructed of a forward spar, main spar, formed sheet metal ribs and stiffeners, a wrap-around skin panel, and formed leading edge skins. The horizontal stabilizer also contains the elevator trim tab actuator. Construction of the elevator consists of a main spar and bellcrank, left and right wrap-around skin panels, and a formed trailing edge skin on the left half of the elevator; the entire trail-

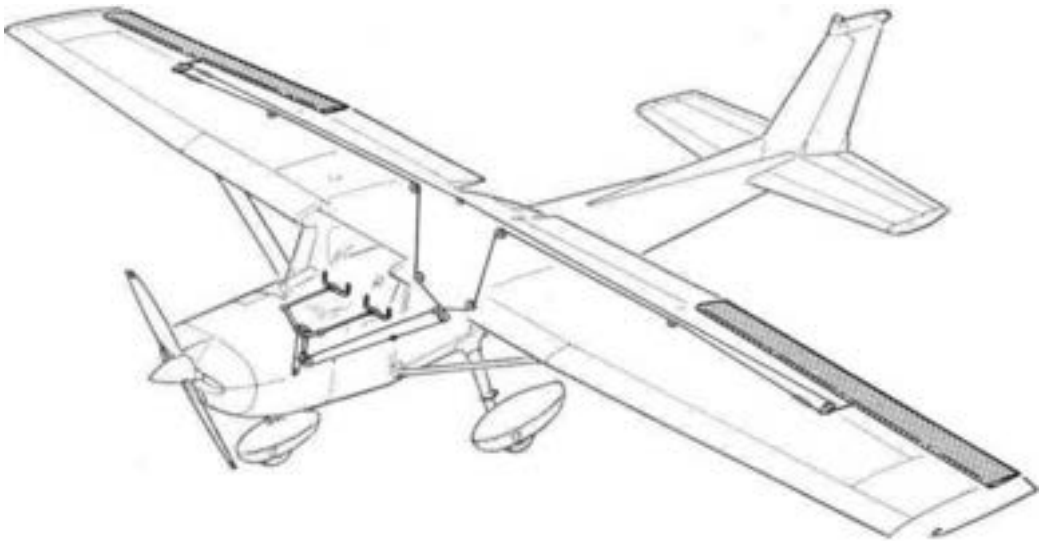

AILERON CONTROL SYSTEM

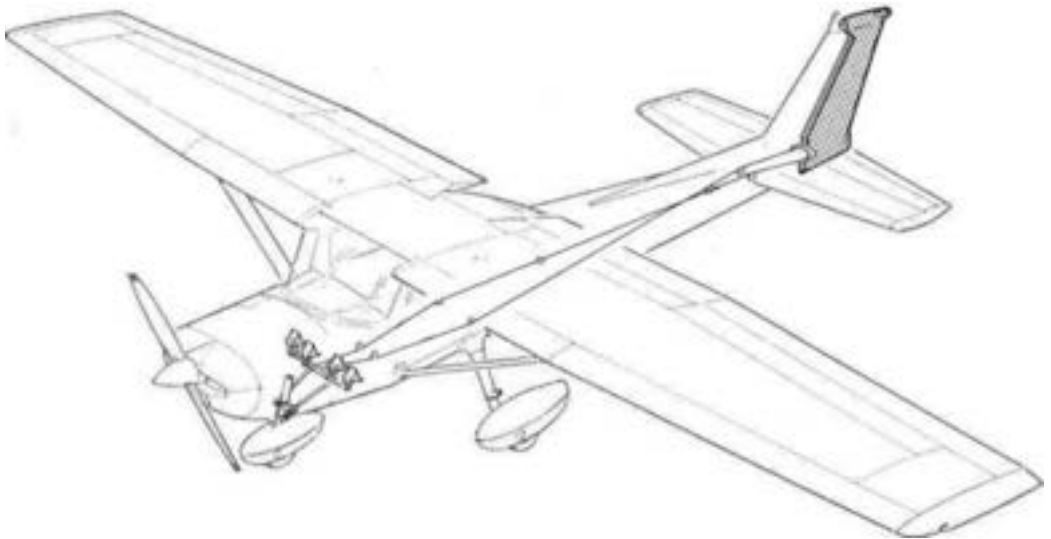

RUDDER CONTROL SYSTEM

Figure 7-1. Flight Control and Trim Systems (Sheet 1 of 2)

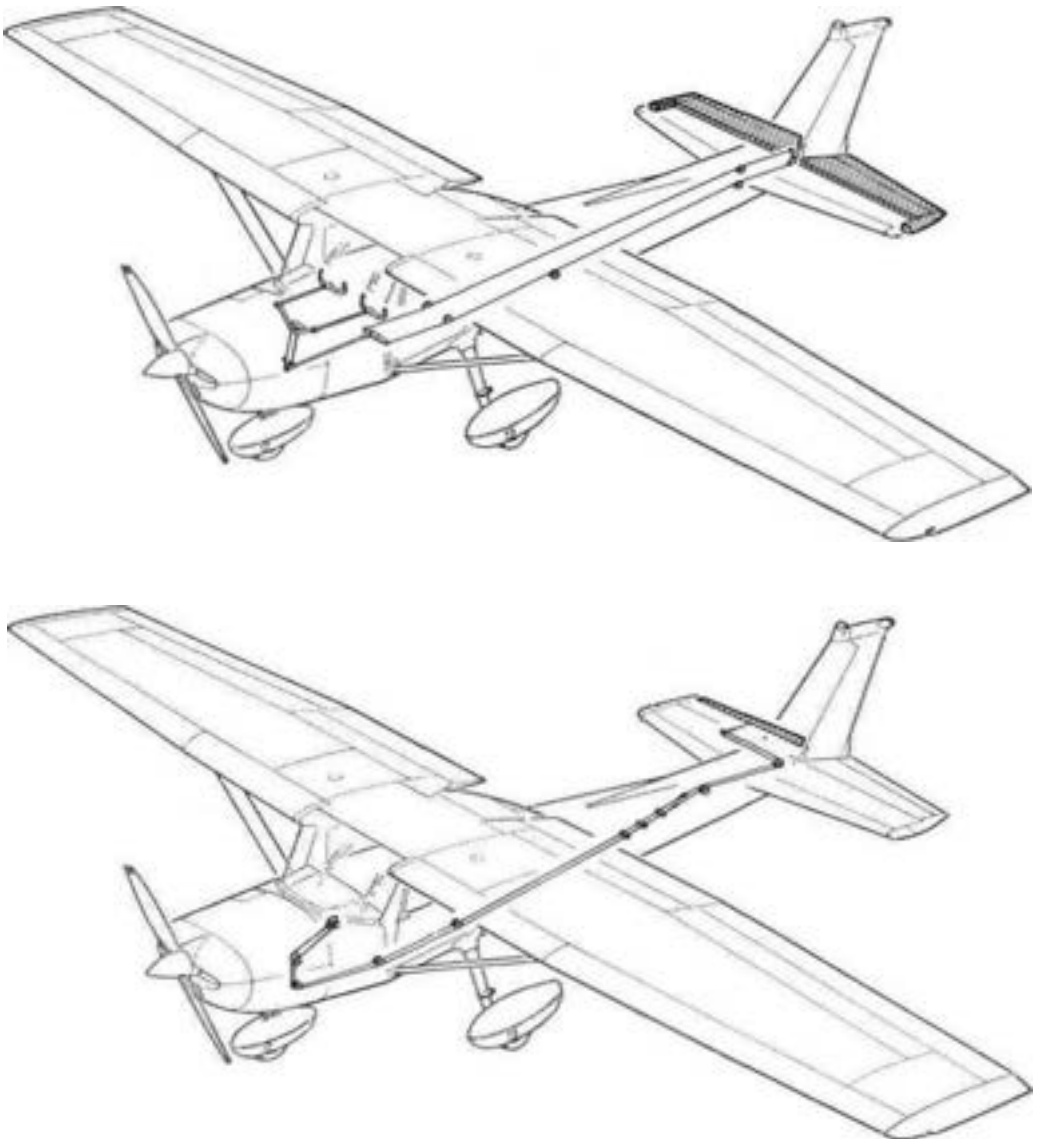

ELEVATOR TRIM CONTROL SYSTEM

Figure 7-1. Flight Control and Trim Systems (Sheet 2 of 2)

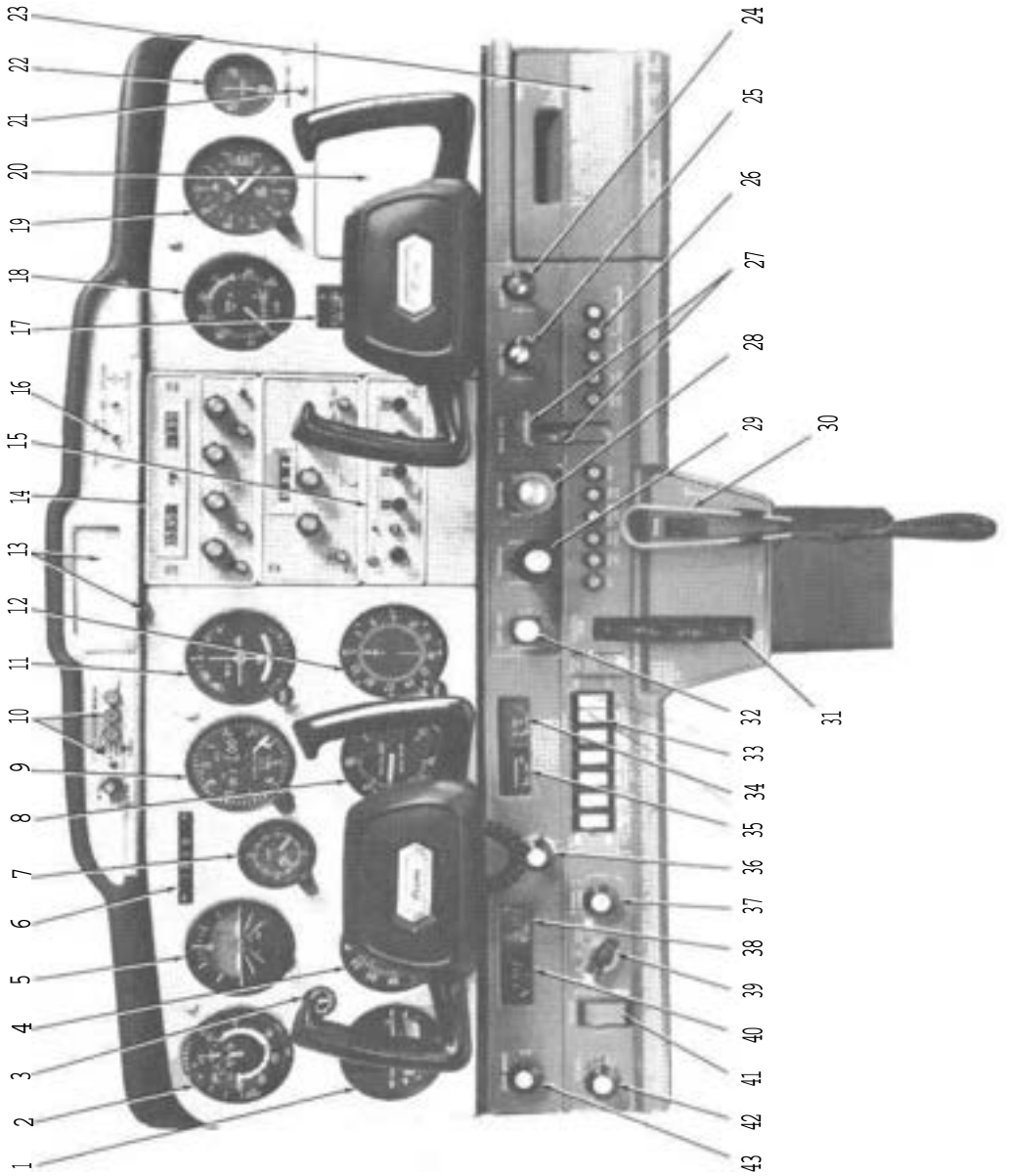

Figure 7-2. Instrument Panel (Sheet 1 of 2)



- |     |   |     |   |
|-----|---|-----|---|
| 1.  | Turn Coordinator                            | 23. | Map Compartment                         |
| 2.  | Airspeed Indicator                          | 24. | Cabin Heat Control Knob                 |
|     | Suction Gage                                | 25. | Cabin Air Control Knob                  |
| 4.  | Directional Indicator                       | 26. | Circuit Breakers                        |
| 5.  | Attitude Indicator                          | 27. | Wing Flap Switch and Position Indicator |
| 6.  | Airplane Registration Number                | 28. | Mixture Control Knob                    |
| 7.  | Clock                                       | 29. | Throttle (With Friction Lock)           |
| 8.  | Rate-of-Climb Indicator                     | 30. | Microphone                              |
| 9.  | Encoding Altimeter                          | 31. | Elevator Trim Control Wheel             |
| 10. | Marker Beacon Indicator Lights and Switches | 32. | Carburetor Heat Control Knob            |
| 11. | Omni Course Indicator                       | 33. | Electrical Switches                     |
| 12. | ADF Bearing Indicator                       | 34. | Oil Pressure Gage                       |
| 13. | Rear View Mirror and Control                | 35. | Oil Temperature Gage                    |
| 14. | Radios                                      | 36. | Cigar Lighter                           |
| 15. | Transponder                                 | 37. | Instrument Panel and Radio              |
| 16. | Audio Control Panel                         |     | Dial Lights Rheostat                    |
| 17. | Flight Hour Recorder                        | 38. | Right Tank Fuel Quantity Indicator      |
| 18. | Tachometer                                  | 39. | Ignition Switch                         |
| 19. | Secondary Altimeter                         | 40. | Left Tank Fuel Quantity Indicator       |
| 20. | Additional Instrument and Radio Space       | 41. | Master Switch                           |
| 21. | Over-Voltage Warning Light                  | 42. | Primer                                  |
| 22. | Ammeter                                     | 43. | Parking Brake Knob                      |

Figure 7-2. Instrument Panel (Sheet 2 of 2)

ing edge of the right half is hinged and forms the elevator trim tab. The leading edge of both left and right elevator tips incorporate extensions which contain balance weights.

## **FLIGHT CONTROLS**

The airplane's flight control system consists of conventional aileron, rudder, and elevator control surfaces (see figure 7-1). The control surfaces are manually operated through mechanical linkage using a control wheel for the ailerons and elevator, and rudder/brake pedals for the rudder.

## **TRIM SYSTEM**

A manually-operated elevator trim tab is provided. Elevator trimming is accomplished through the elevator trim tab by utilizing the vertically mounted trim control wheel. Forward rotation of the trim wheel will trim nose-down; conversely, aft rotation will trim nose-up.

## **INSTRUMENT PANEL**

The instrument panel (see figure 7-2) is designed to place the primary flight instruments directly in front of the pilot. The gyro-operated flight instruments are arranged one above the other, slightly to the left of the control column. To the left of these instruments are the airspeed indicator, turn coordinator, and suction gage. On the right side are the clock, altimeter, rate-of-climb indicator, and navigation instruments. Avionics equipment is stacked approximately on the centerline of the panel, with space for additional equipment on the lower right side of the instrument panel. The right side of the panel also contains the tachometer, ammeter, over-voltage light, and additional instruments such as a flight hour recorder. A subpanel, under the primary instrument panel, contains the fuel quantity indicators, cigar lighter, and engine instruments positioned below the pilot's control wheel. The electrical switches, panel and radio light rheostat knob, ignition and master switches, primer, and parking brake control are located around these instruments. The engine controls, wing flap switch, and cabin air and heat control knobs are to the right of the pilot, along the upper edge of the subpanel. Directly below these controls are the elevator trim control wheel, trim position indicator, microphone, and circuit breakers. A map compartment is on the extreme right side of the subpanel.

For details concerning the instruments, switches, circuit breakers, and controls on this panel, refer in this section to the description of the systems to which, these items are related.

## GROUND CONTROL

Effective ground control while taxiing is accomplished through nose wheel steering by using the rudder pedals; left rudder pedal to steer left and right rudder pedal to steer right. When a rudder pedal is depressed, a spring-loaded steering bungee (which is connected to the nose gear and to the rudder bars) will turn the nose wheel through an arc of approximately  $8.5^{\circ}$  each side of center. By applying either left or right brake, the degree of turn may be increased up to  $30^{\circ}$  each side of center.

Moving the airplane by hand is most easily accomplished by attaching a tow bar to the nose gear strut. If a tow bar is not available, or pushing is required, use the wing struts as push points. Do not use the vertical or horizontal surfaces to move the airplane. If the airplane is to be towed by vehicle, never turn the nose wheel more than  $30^{\circ}$  either side of center or structural damage to the nose gear could result.

The minimum turning radius of the airplane, using differential braking and nose wheel steering during taxi, is approximately 24 feet 8 inches. To obtain a minimum radius turn during ground handling, the airplane may be rotated around either main landing gear by pressing down on the tail cone just forward of the vertical stabilizer to raise the nose wheel off the ground.

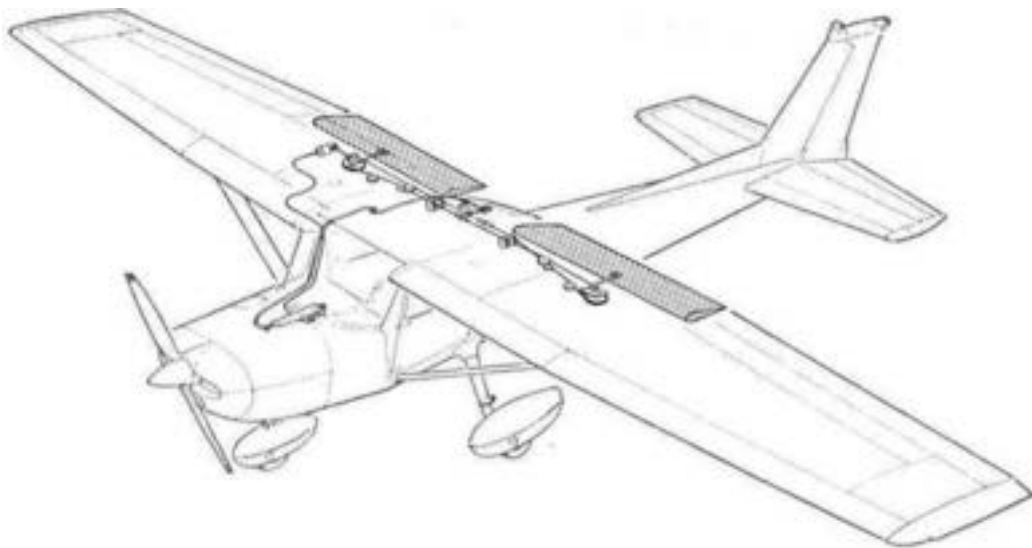

Figure 7-3. Wing Flap System

## WING FLAP SYSTEM

The wing flaps are of the single-slot type (see figure 7-3), and are extended or retracted by positioning the wing flap switch lever on the instrument panel to the desired flap deflection position. The switch lever is moved up or down in a slot in the instrument panel that provides mechanical stops at the 10° and 20° positions. For flap settings greater than 10°, move the switch lever to the right to clear the stop and position it as desired. A scale and pointer on the left side of the switch lever indicates flap travel in degrees. The wing flap system circuit is protected by a 15-ampere circuit breaker, labeled FLAP, on the right side of the instrument panel.

## LANDING GEAR SYSTEM

The landing gear is of the tricycle type with a steerable nose wheel, two main wheels, and wheel fairings. Shock absorption is provided by the tubular spring-steel main landing gear struts and the air/oil nose gear shock strut. Each main gear wheel is equipped with a hydraulic ally actuated disc-type brake on the inboard side of each wheel, and an aerodynamic fairing over each brake.

## BAGGAGE COMPARTMENT

The baggage compartment consists of the area from the back of the pilot and passenger's seats to the aft cabin bulkhead. Access to the baggage compartment is gained from within the airplane cabin. A baggage net with six tie-down straps is provided for securing baggage and is attached by tying the straps to tie-down rings provided in the airplane. When loading the airplane, children should not be placed or permitted in the baggage compartment, unless a child's seat is installed, and any material that might be hazardous to the airplane or occupants should not be placed anywhere in the airplane. For baggage area dimensions, refer to Section 6.

## SEATS

The seating arrangement consists of two separate adjustable seats for the pilot and passenger and, if installed, a child's seat in the rear cabin area. The pilot's and passenger's seats are available in two designs: four-way and six-way adjustable.

Four-way seats may be moved forward or aft, and the seat back angle

changed. To position either seat, lift the lever under the inboard corner of the seat, slide the seat into position, release the lever, and check that the seat is locked in place. To adjust the seat back, pull forward on the knob under the center of the seat and apply pressure to the back. To return the seat back to the upright position, pull forward on the exposed portion of the seat back frame. Both seat backs will also fold full forward.

The six-way seats may be moved forward or aft, adjusted for height, and the seat back angle changed. Position either seat by lifting the tubular handle under the inboard front corner of the seat bottom and slide the seat to the desired position. Release the lever and check that the seat is locked in place. The seats may be raised or lowered two inches, in one inch steps, and should be adjusted prior to flight. To raise or lower either seat, pull forward on a "T" handle under the seat near the inboard corner, force the seat down against spring tension or allow spring tension to raise it to the desired position, release the "T" handle, and then allow the seat to move until it locks in place. Seat back angle is adjustable by rotating a lever on the rear inboard corner of each seat. To adjust either seat back, rotate the lever aft and apply pressure against the back until it stops moving; then release the lever. The seat back may be returned to the upright position by pulling forward on the exposed portion of the lower seat back frame. Check that the release lever has returned to its vertical position. Both seat backs will fold full forward.

A child's seat is available for installation in the rear of the cabin. The seat back is secured to the cabin sidewalls, and the seat bottom is attached to brackets on the floor. This seat is non-adjustable.

## **SEAT BELTS AND SHOULDER HARNESSSES**

All seat positions are equipped with seat belts (see figure 7-4). The pilot's and passenger's seats are also equipped with separate shoulder harnesses. Integrated seat belt/shoulder harnesses with inertia reels can be furnished for the pilot's and passenger's seat positions if desired.

### **SEAT BELTS**

The seat belts used with the pilot's seat, passenger's seat, and the child's seat (if installed) are attached to fittings on the floorboard. The buckle half of the seat belt is inboard of each seat and has a fixed length; the link half of the belt is outboard and is the adjustable part of the belt.

To use the seat belts for the pilot's and passenger's seats, position seat as desired, and then lengthen the link half of the belt as needed by grasping the sides of the link and pulling against the belt. Insert

**STANDARD SHOULDER  
HARNESS**

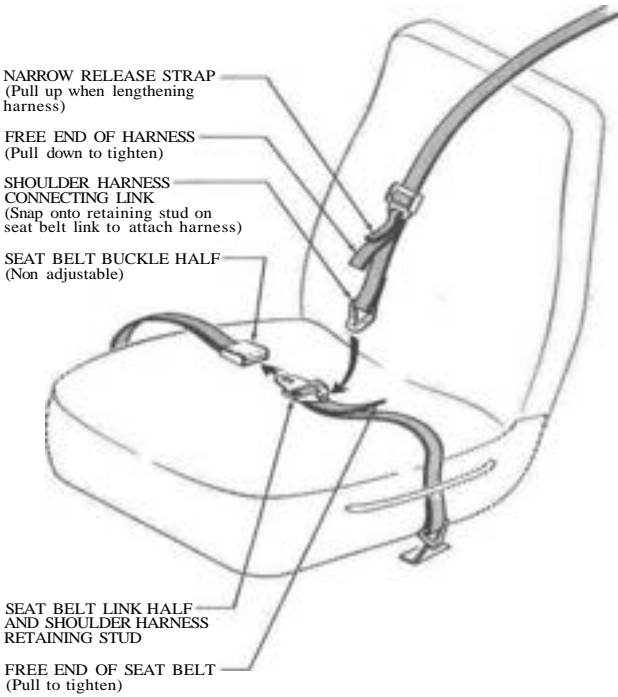

**(PILOTS SEAT SHOWN)**

**SEAT BELT/SHOULDER  
HARNESS WITH INERTIA  
REEL**

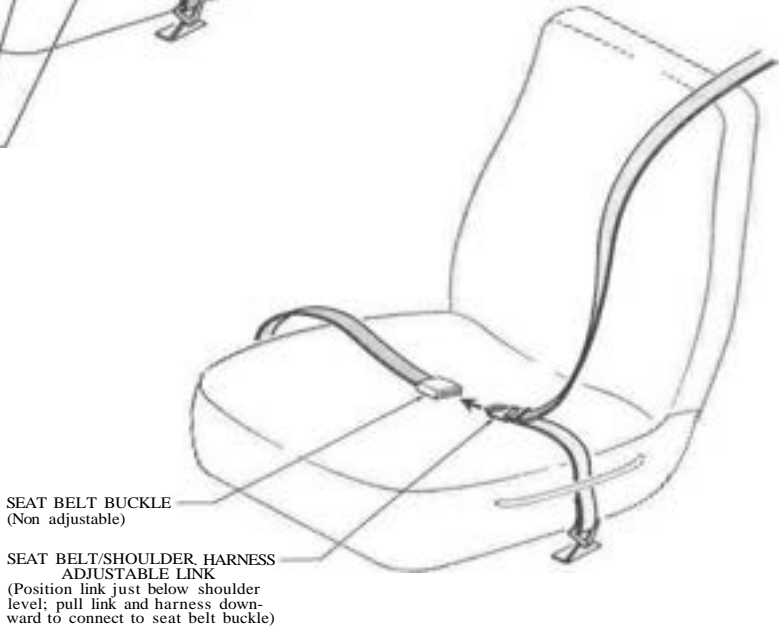

Figure 7-4. Seat Belts and Shoulder Harnesses

and lock the belt link into the buckle. Tighten the belt to a snug fit by pulling the free end of the belt. The seat belt for the child's seat (if installed) is used in the same manner as the belts for the pilot's and passenger's seats. To release the seat belts, grasp the top of the buckle opposite the link and pull upward.

## **SHOULDER HARNESES**

Each shoulder harness is attached to a rear doorpost above the window line and is stowed behind a stowage sheath above the cabin door. To stow the harness, fold it and place it behind the sheath. No harness is available for the child's seat.

The shoulder harnesses are used by fastening and adjusting the seat belt first. Then, lengthen the harness as required by pulling on the connecting link on the end of the harness and the narrow release strap. Snap the connecting link firmly onto the retaining stud on the seat belt link half. Then adjust to length. Removing the harness is accomplished by pulling upward on the narrow release strap, and removing the harness connecting link from the stud on the seat belt link. In an emergency, the shoulder harness may be removed by releasing the seat belt first and allowing the harness, still attached to the link half of the seat belt, to drop to the side of the seat.

Adjustment of the shoulder harness is important. A properly adjusted harness will permit the occupant to lean forward enough to sit completely erect, but prevent excessive forward movement and contact with objects during sudden deceleration. Also, the pilot will want the freedom to reach all controls easily.

## **INTEGRATED SEAT BELT/SHOULDER HARNESES WITH INERTIA REELS**

Integrated seat belt/shoulder harnesses with inertia reels are available for the pilot and front seat passenger. The seat belt/shoulder harnesses extend from inertia reels located in the upper cabin sidewall just aft of each cabin door to attach points outboard of the front seats. A separate seat belt half and buckle is located inboard of the seats. Inertia reels allow complete freedom of body movement. However, in the event of a sudden deceleration, they will lock automatically to protect the occupants.

To use the seat belt/shoulder harness, position the adjustable metal link on the harness at about shoulder level, pull the link and harness downward, and insert the link in the seat belt buckle. Adjust belt tension across the lap by pulling upward on the shoulder harness. Removal is accomplished by releasing the seat belt buckle, which will allow the inertia reel to pull the harness outboard of the seat.

## ENTRANCE DOORS AND CABIN WINDOWS

Entry to, and exit from the airplane is accomplished through either of two entry doors, one on each side of the cabin (refer to Section 6 for cabin and cabin door dimensions). The doors incorporate a recessed exterior and interior door handle, a key-operated door lock (left door only), a door stop mechanism, and an openable window.

To open the doors from outside the airplane, utilize the recessed door handle near the aft edge of each door. Grasp the forward edge of the handle and pull out. To close or open the doors from inside the airplane, use the recessed door handle and arm rest. Both cabin doors, should be checked for security prior to flight, and should not be opened intentionally during flight.

### NOTE

Accidental opening of a cabin door in flight due to improper closing does not constitute a need to land the airplane. The best procedure is to set up the airplane in a trimmed condition at approximately 65 knots, momentarily shove the door outward slightly, and forcefully close the door.

Exit from the airplane is accomplished by grasping the forward edge of the door handle and pulling. To lock the airplane, lock the right cabin door from the inside by lifting up on the lever near the aft edge of the door, close the left cabin door, and using the ignition key, lock the door.

Both cabin doors are equipped with openable windows. The windows are held in the closed position by a lock button equipped over-center latch on the lower edge of the window frame. To open either window, depress the lock button and rotate the latch upward. The windows are equipped with a spring-loaded retaining arm which will help rotate the window outward, and hold it there. If required, the windows may be opened at any speed up to 141 knots. All other cabin windows are of the fixed type and cannot be opened. Two additional fixed windows may be installed in the cabin top.

## CONTROL LOCKS

A control lock is provided to lock the ailerons and elevator control surfaces in a neutral position and prevent damage to these systems by wind buffeting while the airplane is parked. The lock consists of a shaped steel rod with a red metal flag attached to it. The flag is labeled CONTROL LOCK, REMOVE BEFORE STARTING ENGINE. To install the control lock, align the hole in the top of the pilot's control wheel shaft with



the hole in the top of the shaft collar on the instrument panel and insert the rod into the aligned holes. Proper installation of the lock will place the red flag over the ignition switch. In areas where high or gusty winds occur, a control surface lock should be installed over the vertical stabilizer and rudder. The control lock and any other type of locking device should be removed prior to starting the engine.

## ENGINE

The airplane is powered by a horizontally-opposed, four-cylinder, overhead-valve, air-cooled, carbureted engine with a wet sump oil system. The engine is a Continental Model O-200-A and is rated at 100, horsepower at 2750 RPM. Major engine accessories include a vacuum pump, mounted at the front of the engine, and a starter, gear-driven alternator, and dual magnetos, which are mounted on an accessory drive pad at the rear of the engine. Provisions are also made for a full flow oil filter and an oil cooler.

## ENGINE CONTROLS

Engine power is controlled by a throttle located on the lower center portion of the instrument panel. The throttle operates in a conventional manner; in the full forward position, the throttle is open, and in the full aft position, it is closed. A friction lock, which is a round knurled disk, is located at the base of the throttle and is operated by rotating the lock clockwise to increase friction or counterclockwise to decrease it.

The mixture control mounted above the right corner of the control pedestal, is a red knob with raised points around the circumference and is equipped with a lock button in the end of the knob. The rich position is full forward, and full aft is the idle cut-off position. For small adjustments, the control may be moved forward by rotating the knob clockwise, and aft by rotating the knob counterclockwise. For rapid or large adjustments, the knob may be moved forward or aft by depressing the lock button in the end of the control, and then positioning the control as desired.

## ENGINE INSTRUMENTS

Engine operation is monitored by the following instruments: oil pressure gage, oil temperature gage, and a tachometer.

The oil pressure gage, located on the subpanel, is operated by oil pressure. A direct pressure oil line from the engine delivers oil at engine operating pressure to the oil pressure gage. Gage markings indicate

that minimum idling pressure is 10 PSI (red line), the normal operating range is 30 to 60 PSI (green arc), and maximum pressure is 100 PSI (red line).

Oil temperature is indicated by a gage located on the subpanel. The gage is operated by an electrical-resistance type temperature sensor which receives power from the airplane electrical system. Oil temperature limitations are the normal operating range (green arc) which is 38°C (100°F) to 116°C (240°F), and the maximum (red line) which is 116°C (240°F).

The engine-driven mechanical tachometer is located near the upper center portion of the instrument panel. The instrument is calibrated in increments of 100 RPM and indicates both engine and propeller speed. An hour meter below the center of the tachometer dial records elapsed engine time in hours and tenths. Instrument markings include a normal operating range (green arc) of 2000 to 2750 RPM, and a maximum allowable (red line) of 2750 RPM.

## **NEW ENGINE BREAK-IN AND OPERATION**

The engine underwent a run-in at the factory and is ready for the full range of use. It is, however, suggested that cruising be accomplished at 65% to 75% power until a total of 50 hours has accumulated or oil consumption has stabilized. This will ensure proper seating of the rings.

The airplane is delivered from the factory with corrosion preventive oil in the engine. If, during the first 25 hours, oil must be added, use only aviation grade straight mineral oil conforming to Specification No. MIL-L-6082.

## **ENGINE OIL SYSTEM**

An oil sump on the bottom of the engine supplies a total capacity of six quarts to the engine for lubrication (one additional quart is required if a full flow oil filter is installed.) The oil is drawn from the sump through a filter screen on the end of a pick-up tube to the engine-driven oil pump. The pump feeds the oil, under pressure, through a filter screen (full flow oil filter and/or oil cooler, if installed), and is then circulated to the left and right oil galleries. The engine parts are then lubricated, under pressure, from the galleries. Oil pressure to the galleries is regulated by a pressure relief valve at the rear of the right oil gallery. After lubricating the engine, the oil returns to the sump by gravity. If a full flow oil filter is installed, the filter adapter is equipped with a bypass valve which will cause lubricating oil to bypass the filter in the event the filter becomes plugged, or the oil temperature is extremely cold.

An oil filler cap/oil dipstick is located at the rear of the engine on the right side. The filler cap/dipstick is accessible through an access door in the engine cowling. The engine should not be operated on less than four quarts of oil. To minimize loss of oil through the breather, fill to five quarts for normal flights of less than three hours. For extended flight, fill to six quarts (dipstick indication only). For engine oil grade and specifications, refer to Section 8 of this handbook.

An oil quick-drain valve is available to replace the drain plug in the oil sump drain port, and provides quicker, cleaner draining of the engine oil. To drain the oil with this valve installed, slip a hose over the end of the valve and push upward on the end of the valve until it snaps into the open position. Spring clips will hold the valve open. After draining, use a suitable tool to snap the valve into the extended (closed) position and remove the drain hose.

### **IGNITION-STARTER SYSTEM**

Engine ignition is provided by two engine-driven magnetos, and two spark plugs in each cylinder. The right magneto fires both left and right upper spark plugs, and the left magneto fires both left and right lower spark plugs. Normal operation is conducted with both magnetos due to the more complete burning of the fuel-air mixture with dual ignition.

Ignition and starter operation is controlled by a rotary type switch located on the left subpanel. The switch is labeled clockwise, OFF, R, L, BOTH, and START. The engine should be operated on both magnetos (BOTH position) except for magneto checks. The R and L positions are for checking purposes and emergency use only. When the switch is rotated to the spring-loaded START position, (with the master switch in the ON position), the starter contactor is energized and the starter will crank the engine. When the switch is released, it will automatically return to the BOTH position.

### **AIR INDUCTION SYSTEM**

The engine air induction system receives ram air through an intake in the lower front portion of the engine cowling. The intake is covered by an air filter which removes dust and other foreign matter from the induction air. Airflow passing through the filter enters an airbox. After passing through the airbox, induction air enters the inlet in the carburetor which is under the engine, and is then ducted to the engine cylinders through intake manifold tubes. In the event carburetor ice is encountered or the intake filter becomes blocked, alternate heated air can be obtained from the right muffler shroud through a duct to a valve, in the airbox, operated by the carburetor heat control on the

instrument panel. Heated air from the muffler shroud is obtained from an unfiltered outside source. Use of full carburetor heat at full throttle will result in a loss of approximately 200 to 250 RPM.

## **EXHAUST SYSTEM**

Exhaust gas from each cylinder passes through riser assemblies to a muffler and tailpipe on each side of the engine. Each muffler is constructed with a shroud around the outside which forms a heating chamber for carburetor heat and cabin heater air.

## **CARBURETOR AND PRIMING SYSTEM**

The engine is equipped with an up-draft, float-type, fixed jet carburetor mounted on the bottom of the engine. The carburetor is equipped with an enclosed accelerator pump, simplified fuel passages to prevent vapor locking, an idle cut-off mechanism, and a manual mixture control. Fuel is delivered to the carburetor by gravity flow from the fuel system. In the carburetor, fuel is atomized, proportionally mixed with intake air, and delivered to the cylinders through intake manifold tubes. The proportion of atomized fuel to air is controlled, within limits, by the mixture control on the instrument panel.

For easy starting in cold weather, the engine is equipped with a manual primer. The primer is actually a small pump which draws fuel from the fuel strainer when the plunger is pulled out, and injects it into the intake manifold when the plunger is pushed back in. The plunger knob, on the instrument panel, is equipped with a lock and, after being pushed full in, must be rotated either left or right until the knob cannot be pulled out.

## **COOLING SYSTEM**

Ram air for engine cooling enters through two intake openings in the front of the engine cowling. The cooling air is directed around the cylinders and other areas of the engine by baffling, and is then exhausted through an opening at the bottom aft edge of the cowling. No manual cooling system control is provided.

A winterization kit is available for the airplane. The kit consists of two shields to partially cover the cowl nose cap opening, the addition of heat ducting from the right exhaust manifold for additional cabin heat, a carburetor airbox heat outlet cap, insulation for the engine crankcase breather line, and a placard to be installed on the map compartment door. This equipment should be installed for operations in temperatures consistently below  $-7^{\circ}\text{C}$  ( $20^{\circ}\text{F}$ ). Once installed, the crank-

case breather insulation is approved for permanent use regardless of temperature.

## PROPELLER

The airplane is equipped with a two-bladed, fixed-pitch, one-piece forged aluminum alloy propeller which is anodized to retard corrosion. The propeller is 69 inches in diameter.

## FUEL SYSTEM

The airplane may be equipped with either a standard fuel system or a long range system (see figure 7-6). Both systems consist of two vented fuel tanks (one in each wing), a fuel shutoff valve, fuel strainer, manual primer, and carburetor. Refer to figure 7-5 for fuel quantity data for both systems.

Fuel flows by gravity from the two wing tanks to a fuel shutoff valve. With the valve in the ON position, fuel flows through a strainer to the carburetor. From the carburetor, mixed fuel and air flows to the cylinders through intake manifold tubes. The manual primer draws its fuel from the fuel strainer and injects it into the intake manifold.

FUEL QUANTITY DATA (U. S. GALLONS)			
TANKS	TOTAL USABLE FUEL ALL FLIGHT CONDITIONS	TOTAL UNUSABLE FUEL	TOTAL FUEL VOLUME
STANDARD (13 Gal. Each)	22.5	3.5	26.0
LONG RANGE (19 Gal. Each)	35.0	3.0	38.0

Figure 7-5. Fuel Quantity Data

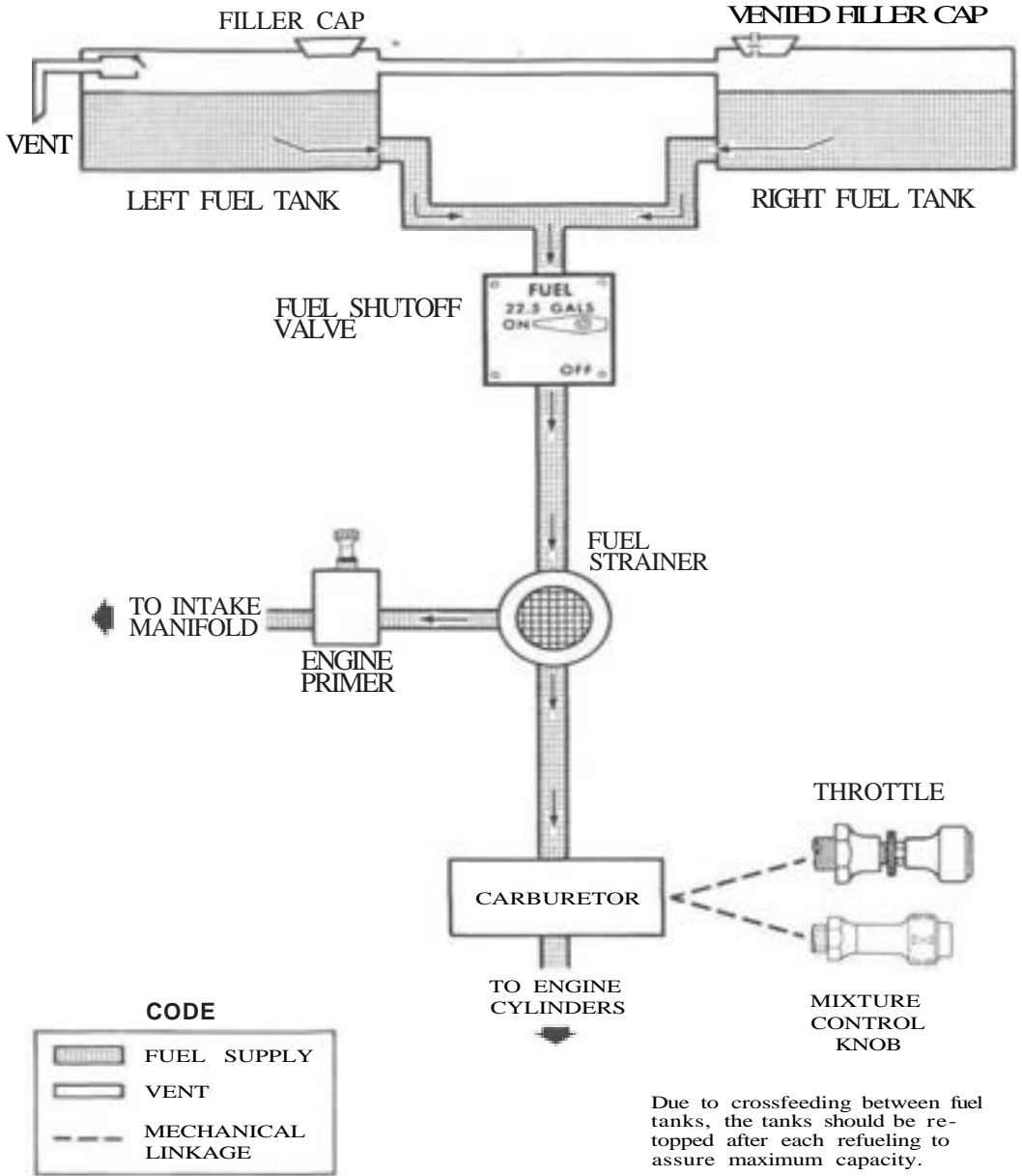

Figure 7-6. Fuel System (Standard and Long Range)

Fuel system venting is essential to system operation. Blockage of the venting system will result in a decreasing fuel flow and eventual engine stoppage. Venting is accomplished by an interconnecting line from the right fuel tank to the left tank. The left tank is vented overboard through a vent line which is equipped with a check valve, and protrudes from the bottom surface of the left wing near the wing strut attach point. The right fuel tank filler cap is also vented.

Fuel quantity is measured by two float-type fuel quantity transmitters (one in each tank) and indicated by two electrically-operated fuel quantity indicators on the lower left portion of the instrument panel. An empty tank is indicated by a red line and the letter E. When an indicator shows an empty tank, approximately 1.75 gallons remain in a standard tank, or 1.5 gallons remain in a long range tank as unusable fuel. The indicators cannot be relied upon for accurate readings during skids, slips, or unusual attitudes.

The fuel system is equipped with drain valves to provide a means for the examination of fuel in the system for contamination and grade. The system should be examined before the first flight of every day and after each refueling, by using the sampler cup provided to drain fuel from the wing tank sumps, and by utilizing the fuel strainer drain under an access panel on the right side of the engine cowling. The fuel tank should be filled after each flight to prevent condensation.

## **BRAKE SYSTEM**

The airplane has a single-disc, hydraulically-actuated brake on each main landing gear wheel. Each brake is connected, by a hydraulic line, to a master cylinder attached to each of the pilot's rudder pedals. The brakes are operated by applying pressure to the top of either the left (pilot's) or right (copilot's) set of rudder pedals, which are interconnected. When the airplane is parked, both main wheel brakes may be set by utilizing the parking brake which is operated by a knob on the lower left side of the instrument panel.

For maximum brake life, keep the brake system properly maintained, and minimize brake usage during taxi operations and landings.

Some of the symptoms of impending brake failure are: gradual decrease in braking action after brake application, noisy or dragging

brakes, soft or spongy pedals, and excessive travel and weak braking action. If any of these symptoms appear, the brake system is in need of immediate attention. If, during taxi or landing roll, braking action decreases, let up on the pedals and then re-apply the brakes with heavy pressure. If the brakes become spongy or pedal travel increases, pumping the pedals should build braking pressure. If one brake becomes weak or fails, use the other brake sparingly while using opposite rudder, as required, to offset the good brake.

## **ELECTRICAL SYSTEM**

Electrical energy (see figure 7-7) is supplied by a 14-volt, direct-current system powered by an engine-driven, 60-amp alternator. The 12-volt, 25-amp hour battery is located on the right, forward side of the firewall. Power is supplied through a single bus bar; a master switch controls this power to all circuits, except the engine ignition system, clock, or flight hour recorder, if installed. The flight hour recorder receives power through activation of an oil pressure switch whenever the engine is operating; the clock is supplied with current at all times. All avionics equipment should be turned off prior to starting the engine or using an external power source to prevent harmful transient voltages from damaging the transistors in this equipment.

### **MASTER SWITCH**

The master switch is a split-rocker type switch labeled MASTER, and is ON in the up position and OFF in the down position. The right half of the switch, labeled BAT, controls all electrical power to the airplane. The left half, labeled ALT, controls the alternator.

Normally, both sides of the master switch should be used simultaneously; however, the BAT side of the switch could be turned ON separately to check equipment while on the ground. The ALT side of the switch, when placed in the OFF position, removes the alternator from the electrical system. With this switch in the OFF position, the entire electrical load is placed on the battery. Continued operation with the alternator switch in the OFF position will reduce battery power low enough to open the battery contactor, remove power from the alternator field, and prevent alternator restart.

### **AMMETER**

The ammeter indicates the flow of current, in amperes, from the alternator to the battery or from the battery to the airplane electrical



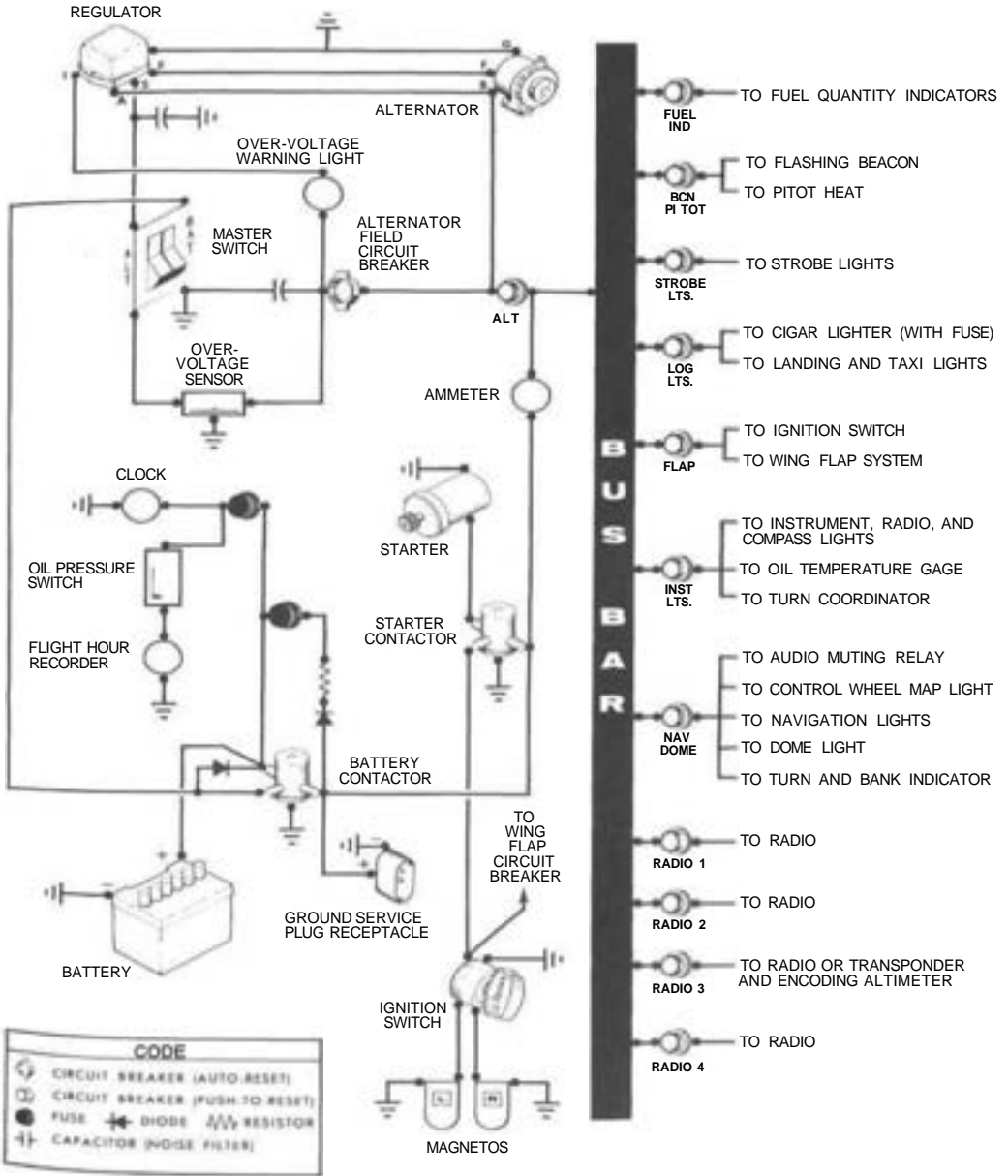

Figure 7-7. Electrical System

system. When the engine is operating and the master switch is turned on, the ammeter indicates the charging rate applied to the battery. In the event the alternator is not functioning or the electrical load exceeds the output of the alternator, the ammeter indicates the battery discharge rate.

## **OVER-VOLTAGE SENSOR AND WARNING LIGHT**

The airplane is equipped with an automatic over-voltage protection system consisting of an over-voltage sensor behind the instrument panel and a red warning light, labeled HIGH VOLTAGE, under the ammeter.

In the event an over-voltage condition occurs, the over-voltage sensor automatically removes alternator field current and shuts down the alternator. The red warning light will then turn on, indicating to the pilot that the alternator is not operating and the battery is supplying all electrical power.

The over-voltage sensor may be reset by turning the master switch off and back on again. If the warning light does not illuminate, normal alternator charging has resumed; however, if the light does illuminate again, a malfunction has occurred, and the flight should be terminated as soon as practical.

The warning light may be tested by momentarily turning off the ALT portion of the master switch and leaving the BAT portion turned on.

## **CIRCUIT BREAKERS AND FUSES**

Most of the electrical circuits in the airplane are protected by "push-to-reset" circuit breakers mounted under the engine controls on the instrument panel. Exceptions to this are the battery contactor closing (external power) circuit, clock, and flight hour recorder circuits which have fuses mounted near the battery. Also, the cigar lighter and control wheel map light are both protected by circuit breakers on the instrument panel, and fuses behind the panel. An automatic-reset type circuit breaker, behind the instrument panel, protects the alternator field and circuitry.

## **GROUND SERVICE PLUG RECEPTACLE**

A ground service plug receptacle may be installed to permit the use of an external power source for cold weather starting and during lengthy maintenance work on the electrical and electronic equipment. The receptacle is located behind a door on the left side of the fuselage near the aft

edge of the cowling.

Just before connecting an external power source (generator type or battery cart), the master switch should be turned ON. This is especially important since it will enable the battery to absorb transient voltages which otherwise might damage the transistor in the electronic equipment.

The battery and external power circuits have been designed to completely eliminate the need to "jumper" across the battery contactor to close it for charging a completely "dead" battery. A special fused circuit in the external power system supplies the needed "jumper" across the contacts so that with a "dead" battery and an external power source applied, turning the master switch ON will close the battery contactor.

## **LIGHTING SYSTEMS**

### **EXTERIOR LIGHTING**

Conventional navigation lights are located on the wing tips and top of the rudder, a single landing light is installed in the cowl nose cap, and a flashing beacon is mounted on top of the vertical fin. Additional lighting is available and includes dual landing/taxi lights in the cowl nose cap and a strobe light on each wing tip. All exterior lights are controlled by rocker type switches on the lower left side of the instrument panel. The switches are ON in the up position and OFF in the down position.

The flashing beacon should not be used when flying through clouds or overcast; the flashing light reflected from water droplets or particles in the atmosphere, particularly at night, can produce vertigo and loss of orientation.

The two high intensity strobe lights will enhance anti-collision protection. However, the lights should be turned off when taxiing in the vicinity of other airplanes, or during night flight through clouds, fog or haze.

### **INTERIOR LIGHTING**

Instrument and control panel lighting is provided by flood lighting and integral lighting. Two concentric rheostat control knobs on the lower left side of the instrument panel, labeled PANEL LT, RADIO LT, control the intensity of both flood and integral lighting.

Instrument and control panel flood lighting consists of a single red

flood light in the forward part of the overhead console. To use the flood lighting, rotate the PANEL LT rheostat control knob clockwise to the desired intensity.

The radio equipment and magnetic compass have integral lighting. The light intensity of all integral lighting is controlled by the RADIO LT rheostat control knob.

A cabin dome light is located in the aft part of the overhead console, and is operated by a switch on the lower portion of the instrument panel. To turn the light on, place the switch in the ON position.

A control wheel map light is available and is mounted on the bottom of the pilot's control wheel. The light illuminates the lower portion of the cabin just forward of the pilot and is helpful when checking maps and other flight data during night operations. To operate the light, first turn on the NAV LIGHTS switch; then adjust the map light's intensity with the knurled disk type rheostat control located at the bottom of the control wheel.

The most probable cause of a light failure is a burned out bulb; however, in the event any of the lighting systems fail to illuminate when turned on, check the appropriate circuit breaker. If the circuit breaker has opened (white button popped out), and there is no obvious indication of a short circuit (smoke or odor), turn off the light switch of the affected lights, reset the breaker, and turn the switch on again. If the breaker opens again, do not reset it.

## **CABIN HEATING, VENTILATING AND DEFROSTING SYSTEM**

The temperature and volume of airflow into the cabin can be regulated to any degree desired by manipulation of the push-pull CABIN HT and CABIN AIR control knobs (see figure 7-8).

Heated fresh air and outside air are blended in a cabin manifold just aft of the firewall by adjustment of the heat and air controls; this air is then vented into the cabin from outlets in the cabin manifold near the pilot's and passenger's feet. Windshield defrost-air is also supplied by a duct leading from the manifold.

Full ventilation air may be obtained by utilization of the adjustable ventilators near the upper left and right corners of the windshield, and by pulling the CABIN AIR control knob out. The CABIN HT control knob must be pushed full in.

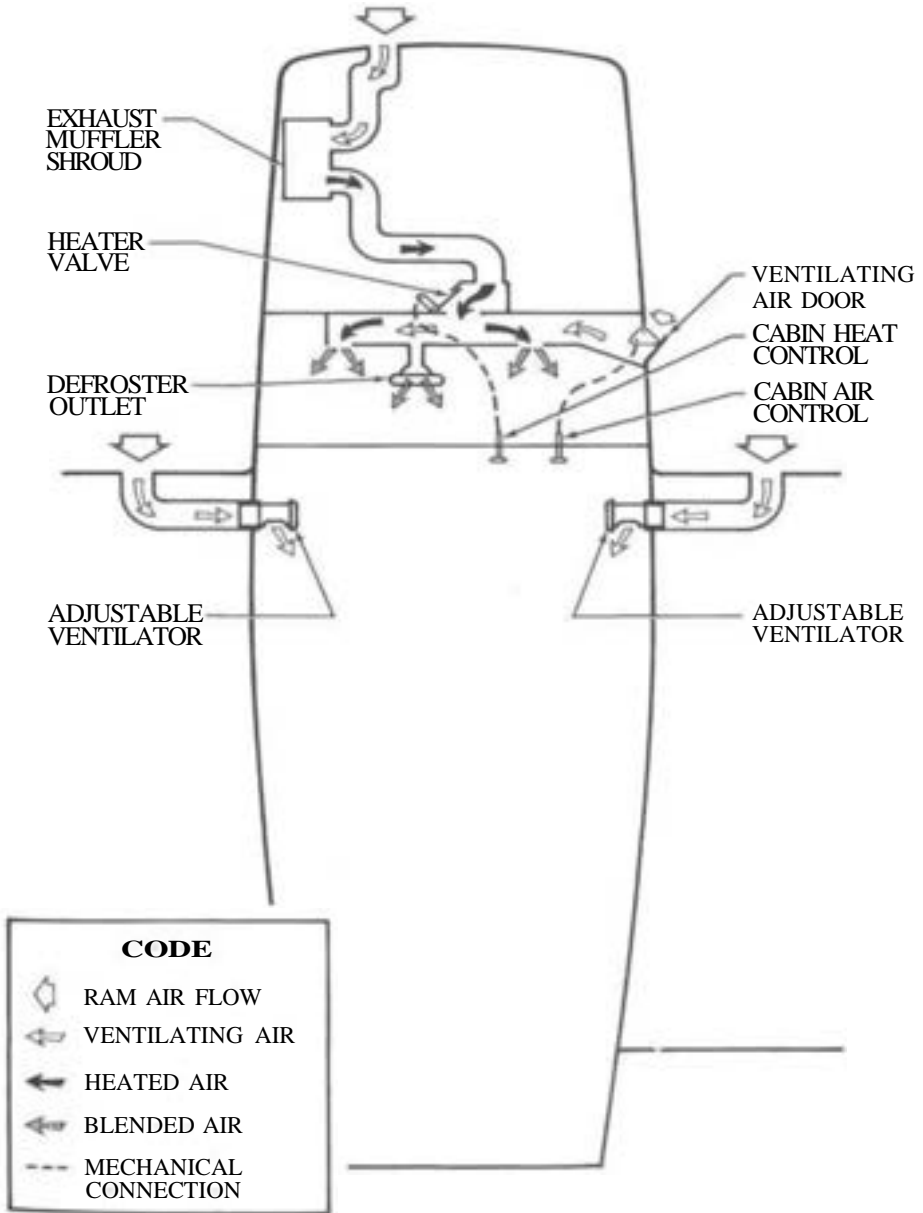

Figure 7-8. Cabin Heating, Ventilating, and Defrosting System

## **PITOT-STATIC SYSTEM AND INSTRUMENTS**

The pitot-static system supplies ram air pressure to the airspeed indicator and static pressure to the airspeed indicator, rate-of-climb indicator and altimeter. The system is composed of a heated pitot tube mounted on the lower surface of the left wing, an external static port on the lower left side of the forward fuselage, and the associated plumbing necessary to connect the instruments to the sources.

The heated pitot system consists of a heating element in the pitot tube, a rocker-type switch labeled PITOT HT on the lower left side of the instrument panel, a 10-amp circuit breaker under the engine controls on the instrument panel, and associated wiring. When the pitot heat switch is turned on, the element in the pitot tube is heated electrically to maintain proper operation in possible icing conditions. Pitot heat should be used only as required.

### **AIRSPEED INDICATOR**

The airspeed indicator is calibrated in knots and miles per hour. Limitation and range markings include the white arc (42 to 85 knots), green arc (47 to 107 knots), yellow arc (107 to 141 knots), and a red line (141 knots).

If a true airspeed indicator is installed, it is equipped with a rotatable ring which works in conjunction with the airspeed indicator dial in a manner similar to the operation of a flight computer. To operate the indicator, first rotate the ring until pressure altitude is aligned with outside air temperature in degrees Fahrenheit. Pressure altitude should not be confused with indicated altitude. To obtain pressure altitude, momentarily set the barometric scale on the altimeter to 29.92 and read pressure altitude on the altimeter. Be sure to return the altimeter barometric scale to the original barometric setting after pressure altitude has been obtained. Having set the ring to correct for altitude and temperature, then read the airspeed shown on the rotatable ring by the indicator pointer. For best accuracy, this indication should be corrected to calibrated airspeed by referring to the Airspeed Calibration chart in Section 5. Knowing the calibrated airspeed, read true airspeed on the ring opposite the calibrated airspeed.

### **RATE-OF-CLIMB INDICATOR**

The rate-of-climb indicator depicts airplane rate of climb or descent in feet per minute. The pointer is actuated by atmospheric pressure changes resulting from changes of altitude as supplied by the static source.

## **ALTIMETER**

Airplane altitude is depicted by a barometric type altimeter. A knob near the lower left portion of the indicator provides adjustment of the instrument's barometric scale to the current altimeter setting.

## **VACUUM SYSTEM AND INSTRUMENTS**

An engine-driven vacuum system (see figure 7-9) provides the suction necessary to operate the attitude indicator and directional indicator. The system consists of a vacuum pump mounted on the engine, a vacuum relief valve and vacuum system air filter on the aft side of the firewall below the instrument panel, and instruments (including a suction gage) on the left side of the instrument panel.

### **ATTITUDE INDICATOR**

An attitude indicator is available and gives a visual indication of flight attitude. Bank attitude is presented by a pointer at the top of the indicator relative to the bank scale which has index marks at 10°, 20°, 30°, 60°, and 90° either side of the center mark. Pitch and roll attitudes are presented by a miniature airplane in relation to the horizon bar. A knob at the bottom of the instrument is provided for in-flight adjustment of the miniature airplane to the horizon bar for a more accurate flight attitude indication.

### **DIRECTIONAL INDICATOR**

A directional indicator is available and displays airplane heading on a compass card in relation to a fixed simulated airplane image and index. The directional indicator will precess slightly over a period of time. Therefore, the compass card should be set in accordance with the magnetic compass just prior to takeoff, and occasionally re-adjusted on extended flights. A knob on the lower left edge of the instrument is used to adjust the compass card to correct for any precession.

### **SUCTION GAGE**

A suction gage is located on the left side of the instrument panel and indicates, in inches of mercury, the amount of suction available for operation of the attitude indicator and directional indicator. The desired suction range is 4.6 to 5.4 inches of mercury. A suction reading below this range may indicate a system malfunction or improper adjustment, and in this case, the indicators should not be considered reliable.

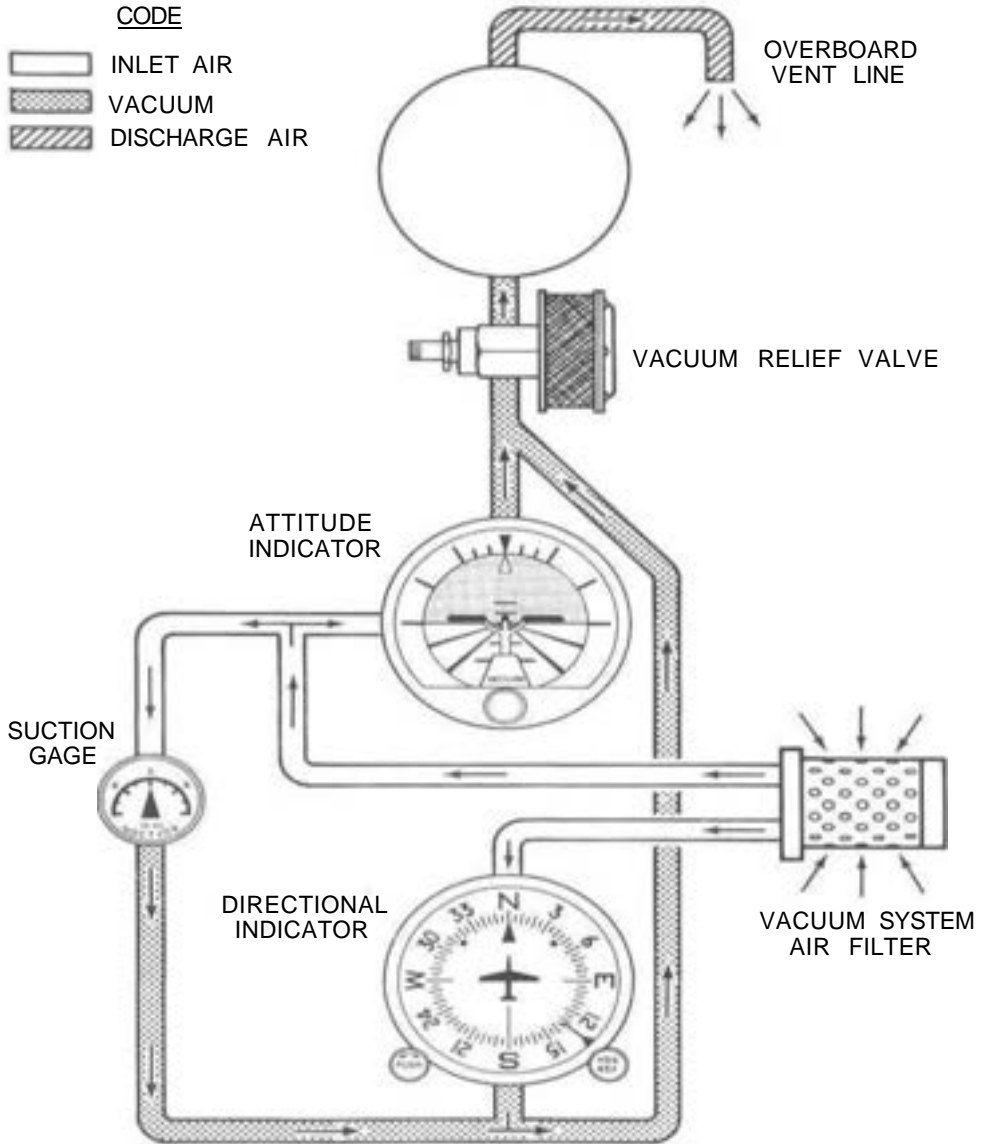

Figure 7-9. Vacuum System



## STALL WARNING SYSTEM

The airplane is equipped with a pneumatic-type stall warning system consisting of an inlet in the leading edge of the left wing, an air-operated horn near the upper left corner of the windshield, and associated plumbing. As the airplane approaches a stall, the low pressure on the upper surface of the wing moves forward around the leading edge of the wing. This low pressure creates a differential pressure in the stall warning system which draws air through the warning horn, resulting in an audible warning at 5 to 10 knots above stall in all flight conditions.

The stall warning system should be checked during the preflight inspection by placing a clean handkerchief over the vent opening and applying suction. A sound from the warning horn will confirm that the system is operative.

## AVIONICS SUPPORT EQUIPMENT

The airplane may, at the owner's discretion, be equipped with various types of avionics support equipment such as an audio control panel and static dischargers. The following paragraphs discuss these items.

### AUDIO CONTROL PANEL

Operation of radio equipment is covered in Section 9 of this handbook. When one or more radios is installed, a transmitter/audio switching system is provided (see figure 7-10). The operation of this switching system is described in the following paragraphs.

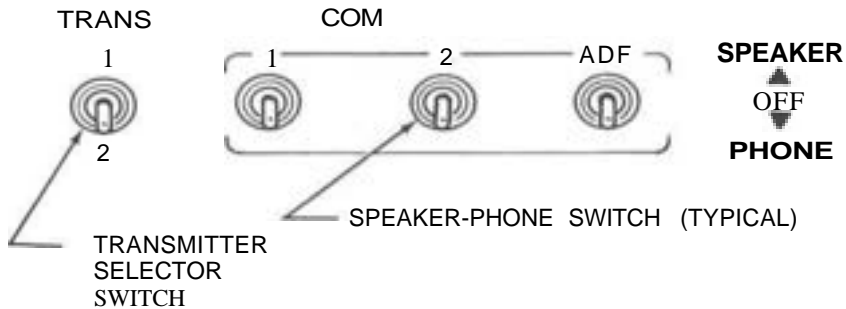

Figure 7-10. Audio Control Panel

The transmitter selector switch is labeled TRANS, and has two positions. When two transmitters are installed, it is necessary to switch the microphone to the radio unit the pilot desires to use for transmission. This is accomplished by placing the transmitter selector switch in the position corresponding to the radio unit which is to be used. The up position selects the upper transmitter and the down position selects the lower transmitter.

The installation of Cessna radio equipment provides certain audio back-up capabilities and transmitter selector switch functions that the pilot should be familiar with. When the transmitter selector switch is placed in the No. 1 or No. 2 position, the audio amplifier of the corresponding transceiver is utilized to provide the speaker audio for all radios. If the audio amplifier in the selected transceiver fails, as evidenced by loss of speaker audio for all radios, place the transmitter selector switch in the other transceiver position. Since an audio amplifier is not utilized for headphones, a malfunctioning amplifier will not affect headphone operation.

The speaker-phone switches determine whether the output of the receiver in use is fed to the headphones or through the audio amplifier to the speaker. Place the switch for the desired receiving system either in the up position for speaker operation or in the down position for headphones. The center OFF position will remove receiver output to either headphones or the speaker.

## **STATIC DISCHARGERS**

If frequent IFR flights are planned, installation of wick-type static dischargers is recommended to improve radio communications during flight through dust or various forms of precipitation (rain, snow or ice crystals). Under these conditions, the build-up and discharge of static electricity from the trailing edges of the wings, rudder, elevator, propeller tips, and radio antennas can result in loss of usable radio signals on all communications and navigation radio equipment. Usually the ADF is first to be affected and VHF communication equipment is the last to be affected.

Installation of static dischargers reduces interference from precipitation static, but it is possible to encounter severe precipitation static conditions which might cause the loss of radio signals, even with static dischargers installed. Whenever possible, avoid known severe precipitation areas to prevent loss of dependable radio signals. If avoidance is impractical, minimize airspeed and anticipate temporary loss of radio signals while in these areas.

# SECTION 8

## AIRPLANE HANDLING, SERVICE & MAINTENANCE

### TABLE OF CONTENTS

	Page
Introduction	8-3
Identification Plate	8-3
Owner Follow-Up System	8-3
Publications	8-3
Airplane File	8-4
Airplane Inspection Periods	8-5
FAA Required Inspections	8-5
Cessna Progressive Care	8-6
Cessna Customer Care Program	8-6
Pilot Conducted Preventive Maintenance	8-7
Alterations or Repairs	8-7
Ground Handling	8-7
Towing	8-7
Parking	8-7
Tie-Down	8-8
Jacking	8-8
Leveling	8-9
Flyable Storage	8-9
Servicing	8-10
Engine Oil	8-10
Fuel	8-11
Landing Gear	8-11
Cleaning and Care	8-12
Windshield-Windows	8-12
Painted Surfaces	8-12
Propeller Care	8-13
Engine Care	8-13
Interior Care	8-13



## **INTRODUCTION**

This section contains factory-recommended procedures for proper ground handling and routine care and servicing of your Cessna. It also identifies certain inspection and maintenance requirements which must be followed if your airplane is to retain that new-plane performance and dependability. It is wise to follow a planned schedule of lubrication and preventive maintenance based on climatic and flying conditions encountered in your locality.

Keep in touch with your Cessna Dealer and take advantage of his knowledge and experience. He knows your airplane and how to maintain it. He will remind you when lubrications and oil changes are necessary, and about other seasonal and periodic services.

## **IDENTIFICATION PLATE**

All correspondence regarding your airplane should include the SERIAL NUMBER. The Serial Number, Model Number, Production Certificate Number (PC) and Type Certificate Number (TC) can be found on the Identification Plate, located on the cabin floor below the left rear corner of the pilot's seat. The plate is accessible by sliding the seat forward and lifting the carpet in this area. Located adjacent to the Identification Plate is a Finish and Trim Plate which contains a code describing the interior color scheme and exterior paint combination of the airplane. The code may be used in conjunction with an applicable Parts Catalog if finish and trim information is needed.

## **OWNER FOLLOW-UP SYSTEM**

Your Cessna Dealer has an Owner Follow-Up System to notify you when he receives information that applies to your Cessna. In addition, if you wish, you may choose to receive similar notification, in the form of Service Letters, directly from the Cessna Customer Services Department. A subscription form is supplied in your Customer Care Program book for your use, should you choose to request this service. Your Cessna Dealer will be glad to supply you with details concerning these follow-up programs, and stands ready, through his Service Department, to supply you with fast, efficient, low-cost service.

## **PUBLICATIONS**

Various publications and flight operation aids are furnished in the

airplane when delivered from the factory. These items are listed below.

CUSTOMER CARE PROGRAM BOOK

PILOT'S OPERATING HANDBOOK/SUPPLEMENTS FOR YOUR  
AIRPLANE  
AVIONICS

PILOT'S CHECKLISTS

POWER COMPUTER

SALES AND SERVICE DEALER DIRECTORY

DO'S AND DON'TS ENGINE BOOKLET

The following additional publications, plus many other supplies that are applicable to your airplane, are available from your Cessna Dealer.

SERVICE MANUALS AND PARTS CATALOGS FOR YOUR  
AIRPLANE  
ENGINE AND ACCESSORIES  
AVIONICS

Your Cessna Dealer has a Customer Care Supplies Catalog covering all available items, many of which he keeps on hand. He will be happy to place an order for any item which is not in stock.

## AIRPLANE FILE

There are miscellaneous data, information and licenses that are a part of the airplane file. The following is a checklist for that file. In addition, a periodic check should be made of the latest Federal Aviation Regulations to ensure that all data requirements are met.

- A. To be displayed in the airplane at all times:
  - (1) Aircraft Airworthiness Certificate (FAA Form 8100-2).
  - (2) Aircraft Registration Certificate (FAA Form 8050-3).
  - (3) Aircraft Radio Station License, if transmitter installed (FCC Form 556).
  
- B. To be carried in the airplane at all times:
  - (1) Weight and Balance, and associated papers (latest copy of the Repair and Alteration Form, FAA Form 337; if applicable).
  - (2) Equipment List.

C. To be made available upon request:

- (1) Airplane Log Book.
- (2) Engine Log Book.

Most of the items listed are required by the United States Federal Aviation Regulations. Since the Regulations of other nations may require other documents and data, owners of airplanes not registered in the United States should check with their own aviation officials to determine their individual requirements.

Cessna recommends that these items, plus the Pilot's Operating Handbook, Pilot's Checklists, Power Computer, Customer Care Program book and Customer Care Card, be carried in the airplane at all times.

## **AIRPLANE INSPECTION PERIODS**

### **FAA REQUIRED INSPECTIONS**

As required by Federal Aviation Regulations, all civil aircraft of U. S. registry must undergo a complete inspection (annual) each twelve calendar months. In addition to the required ANNUAL inspection, aircraft operated commercially (for hire) must have a complete inspection every 100 hours of operation.

The FAA may require other inspections by the issuance of airworthiness directives applicable to the airplane, engine, propeller and components. It is the responsibility of the owner/operator to ensure compliance with all applicable airworthiness directives and, when the inspections are repetitive, to take appropriate steps to prevent inadvertent noncompliance.

In lieu of the 100 HOUR and ANNUAL inspection requirements, an airplane may be inspected in accordance with a progressive inspection schedule, which allows the work load to be divided into smaller operations what can be accomplished in

The CESSNA PROGRESSIVE CARE PROGRAM has been developed to Provide a modern progressive inspection schedule that satisfies the complete airplane inspection requirements of both the 100 HOUR and ANNUAL inspections as applicable to Cessna airplanes. The program assists the owner in his responsibility to comply with all FAA inspection requirements, while ensuring timely replacement of life-limited parts and adherence to factory-recommended inspection intervals and maintenance procedures.

## **CESSNA PROGRESSIVE CARE**

The Cessna Progressive Care Program has been designed to help you realize maximum utilization of your airplane at a minimum cost and downtime. Under this program, your airplane is inspected and maintained in four operations at 50-hour intervals during a 200-hour period. The operations are recycled each 200 hours and are recorded in a specially provided Aircraft Inspection Log as each operation is conducted.

The Cessna Aircraft Company recommends Progressive Care for airplanes that are being flown 200 hours or more per year, and the 100-hour inspection for all other airplanes. The procedures for the Progressive Care Program and the 100-hour inspection have been carefully worked out by the factory and are followed by the Cessna Dealer Organization. The complete familiarity of Cessna Dealers with Cessna equipment and factory-approved procedures provides the highest level of service possible at lower cost to Cessna owners.

Regardless of the inspection method selected by the owner, he should keep in mind that FAR Part 43 and FAR Part 91 establishes the requirement that properly certified agencies or personnel accomplish all required FAA inspections and most of the manufacturer recommended inspections.

## **CESSNA CUSTOMER CARE PROGRAM**

Specific benefits and provisions of the CESSNA WARRANTY plus other important benefits for you are contained in your CUSTOMER CARE PROGRAM book supplied with your airplane. You will want to thoroughly review your Customer Care Program book and keep it in your airplane at all times.

Coupons attached to the Program book entitle you to an initial inspection and either a Progressive Care Operation No. 1 or the first 100-hour inspection within the first 6 months of ownership at no charge to you. If you take delivery from your Dealer, the initial inspection will have been performed before delivery of the airplane to you. If you pick up your airplane at the factory, plan to take it to your Dealer reasonably soon after you take delivery, so the initial inspection may be performed allowing the Dealer to make any minor adjustments which may be necessary.

You will also want to return to your Dealer either at 50 hours for your first Progressive Care Operation, or at 100 hours for your first 100-hour inspection depending on which program you choose to establish for your airplane. While these important inspections will be performed for you by any Cessna Dealer, in most cases you will prefer to have the Dealer from whom you purchased the airplane accomplish this work.



## **PILOT CONDUCTED PREVENTIVE MAINTENANCE**

A certified pilot who owns or operates an airplane not used as an air carrier is authorized by FAR Part 43 to perform limited maintenance on his airplane. Refer to FAR Part 43 for a list of the specific maintenance operations which are allowed.

### **NOTE**

Pilots operating airplanes of other than U. S. registry should refer to the regulations of the country of certification for information on preventive maintenance that may be performed by pilots.

A Service Manual should be obtained prior to performing any preventive maintenance to ensure that proper procedures are followed. Your Cessna Dealer should be contacted for further information or for required maintenance which must be accomplished by appropriately licensed personnel.

## **ALTERATIONS OR REPAIRS**

It is essential that the FAA be contacted prior to any alterations on the airplane to ensure that airworthiness of the airplane is not violated. Alterations or repairs to the airplane must be accomplished by licensed personnel.

## **GROUND HANDLING**

### **TOWING**

The airplane is most easily and safely maneuvered by hand with the tow-bar attached to the nose wheel. When towing with a vehicle, do not exceed the nose gear turning angle of 30° either side of center, or damage to the gear will result. If the airplane is "towed or pushed over a rough surface during hangaring, watch that the normal cushioning action of the nose strut does not cause excessive vertical movement of the tail and the resulting contact with low hangar doors or structure. A flat nose tire or deflated strut will also increase tail height.

### **PARKING**

When parking the airplane, head into the wind and set the parking brakes. Do not set the parking brakes during cold weather when accumu-

lated moisture may freeze the brakes, or when the brakes are overheated, install the control wheel lock and chock the wheels. In severe weather and high wind conditions, tie the airplane down as outlined in the following paragraph.

## **TIE-DOWN**

Proper tie-down procedure is the best precaution against damage to the parked airplane by gusty or strong winds. To tie-down the airplane securely, proceed as follows:

- (1) Set the parking brake and install the control wheel lock.
- (2) Install a surface control lock between each aileron and flap.
- (3) Tie sufficiently strong ropes or chains (700 pounds tensile strength) to the wing and tail tie-down fittings and secure each rope to a ramp tie-down.
- (4) Install a surface control lock over the fin and rudder.
- (5) Tie a rope (no chains or cables) to an exposed portion of the engine mount and secure to a ramp tie-down.
- (6) Install a pitot tube cover.

## **JACKING**

When a requirement exists to jack the entire airplane off the ground, or when wing jack points are used in the jacking operation, refer to the Service Manual for specific procedures and equipment required.

Individual main gear may be jacked by using the jack pad which is incorporated in the main landing gear strut step bracket. When using the individual gear strut jack pad, flexibility of the gear strut will cause the main wheel to slide inboard as the wheel is raised, tilting the jack. The jack must then be lowered for a second jacking operation. Do not jack both main wheels simultaneously using the individual main gear jack pads.

If nose gear maintenance is required, the nose wheel may be raised off the ground by pressing down on a tailcone bulkhead, just forward of the horizontal stabilizer, and allowing the tail to rest on the tail tie-down ring

### **NOTE**

Do not apply pressure on the elevator or outboard stabilizer surfaces. When pushing on the tailcone, always apply pressure at a bulkhead to avoid buckling the skin.

To assist in raising and holding the nose wheel off the ground, weight down the tail by placing sand-bags, or suitable weight, on each side of the

horizontal stabilizer, next to the fuselage. If ground anchors are available, the tail should be securely tied down.

#### NOTE

Ensure that the nose will be held off the ground under all conditions by means of suitable stands or supports under weight supporting bulkheads near the nose of the airplane.

#### LEVELING

Longitudinal leveling of the airplane is accomplished by placing a level on leveling screws located at stations 94.63 and 132.94 on the left side of the tailcone. Deflate the nose tire and/or lower or raise the nose strut to properly center the bubble in the level. Corresponding points on both upper door sills may be used to level the airplane laterally.

#### FLYABLE STORAGE

Airplanes placed in non-operational storage for a maximum of 30 days or those which receive only intermittent operational use for the first 25 hours are considered in flyable storage status. Every seventh day during these periods, the propeller should be rotated by hand through five revolutions. This action "limbers" the oil and prevents any accumulation of corrosion on engine cylinder walls.

#### WARNING

For maximum safety, check that the ignition switch is OFF, the throttle is closed, the mixture control is in the idle cut-off position, and the airplane is secured before rotating the propeller by hand. Do not stand within the arc of the propeller blades while turning the propeller.

After 30 days, the airplane should be flown for 30 minutes or a ground runup should be made just long enough to produce an oil temperature within the lower green arc range. Excessive ground runup should be avoided.

Engine runup also helps to eliminate excessive accumulations of water in the fuel system and other air spaces in the engine. Keep fuel tanks full to minimize condensation in the tanks. Keep the battery fully charged to prevent the electrolyte from freezing in cold weather. If the airplane is to be stored temporarily, or indefinitely, refer to the Service Manual for proper storage procedures.

## SERVICING

In addition to the PREFLIGHT INSPECTION covered in Section 4, COMPLETE servicing, inspection, and test requirements for your airplane are detailed in the Service Manual. The Service Manual outlines all items which require attention at 50, 100, and 200 hour intervals plus those items which require servicing, inspection, and/or testing at special intervals.

Since Cessna Dealers conduct all service, inspection, and test procedures in accordance with applicable Service Manuals, it is recommended that you contact your Cessna Dealer concerning these requirements and begin scheduling your airplane for service at the recommended intervals.

Cessna Progressive Care ensures that these requirements are accomplished at the required intervals to comply with the 100-hour or ANNUAL inspection as previously covered.

Depending on various flight operations, your local Government Aviation Agency may require additional service, inspections, or tests. For these regulatory requirements, owners should check with local aviation officials where the airplane is being operated.

For quick and ready reference, quantities, materials, and specifications for frequently used service items are as follows.

### ENGINE OIL

GRADE -- Aviation Grade SAE 40 Above 4° C(40°F).

Aviation Grade SAE 10W30 or SAE 20 Below 4°C(40°F).

Multi-viscosity oil with a range of SAE 10W30 is recommended for improved starting in cold weather. Ashless dispersant oil, conforming to Continental Motors Specification MHS-24A, must be used.

#### NOTE

Your Cessna was delivered from the factory with a corrosion preventive aircraft engine oil. If oil must be added during the first 25 hours, use only aviation grade straight mineral oil conforming to Specification No. MIL-L-6082.

CAPACITY OF ENGINE SUMP -- 6 Quarts.

Do not operate on less than 4 quarts. To minimize loss of oil through breather, fill to 5 quart level for normal flights of less than 3 hours. For extended flight, fill to 6 quarts. These quantities refer to oil dipstick level readings. During oil and oil filter changes, one additional quart is required when the filter element is changed.

**OIL AND OIL FILTER CHANGE --**

After the first 25 hours of operation, drain engine oil sump and clean the oil pressure screen. If an oil filter is installed, change the filter element at this time. Refill sump with straight mineral oil and use until a total of 50 hours has accumulated or oil consumption has stabilized; then change to dispersant oil. On airplanes not equipped with an oil filter, drain the engine oil sump and clean the oil pressure screen each 50 hours thereafter. On airplanes which have an oil filter, the oil change interval may be extended to 100-hour intervals, providing the oil filter element is changed at 50-hour intervals. Change engine oil at least every 6 months even though less than the recommended hours have accumulated. Reduce intervals for prolonged operation in dusty areas, cold climates, or when short flights and long idle periods result in sludging conditions.

**FUEL**

**APPROVED FUEL GRADES (AND COLORS) --**

80 (Formerly 80/87) Grade Aviation Fuel (Red).

100LL Grade Aviation Fuel (Blue).

100 (formerly 100/130) Grade Aviation Fuel (Green).

**CAPACITY EACH STANDARD TANK — 13 Gallons.**

**CAPACITY EACH LONG RANGE TANK -- 19 Gallons.**

**NOTE**

Due to cross-feeding between fuel tanks, the tanks should be re-topped after each refueling to assure maximum capacity.

**LANDING GEAR**

**NOSE WHEEL TIRE PRESSURE -- 30 PSI on 5.00-5, 4-Ply Rated Tire.**

**MAIN WHEEL TIRE PRESSURE -- 21 PSI on 6.00-6, 4-Ply Rated Tires.**

**NOSE GEAR SHOCK STRUT --**

Keep filled with MIL-H-5606 hydraulic fluid and inflated with air to 20 PSI. Do not over-inflate.

## **CLEANING AND CARE**

### **WINDSHIELD-WINDOWS**

The plastic windshield and windows should be cleaned with an aircraft windshield cleaner. Apply the cleaner sparingly with soft cloths, and rub with moderate pressure until all dirt, oil scum and bug stains are removed. Allow the cleaner to dry, then wipe it off with soft flannel cloths.

If a windshield cleaner is not available, the plastic can be cleaned with soft cloths moistened with Stoddard solvent to remove oil and grease.

#### **NOTE**

Never use gasoline, benzine, alcohol, acetone, carbon tetrachloride, fire extinguisher or anti-ice fluid, lacquer thinner or glass cleaner to clean the plastic. These materials will attack the plastic and may cause it to craze.

Follow by carefully washing with a mild detergent and plenty of water. Rinse thoroughly, then dry with a clean moist chamois. Do not rub the plastic with a dry cloth since this builds up an electrostatic charge which attracts dust. Waxing with a good commercial wax will finish the cleaning job. A thin, even coat of wax, polished out by hand with clean soft flannel cloths, will fill in minor scratches and help prevent further scratching.

Do not use a canvas cover on the windshield unless freezing rain or sleet is anticipated since the cover may scratch the plastic surface.

### **PAINTED SURFACES**

The painted exterior surfaces of your new Cessna have a durable, long lasting finish and, under normal conditions, require no polishing or buffing. Approximately 15 days are required for the paint to cure completely; in most cases, the curing period will have been completed prior to delivery of the airplane. In the event that polishing or buffing is required within the curing period, it is recommended that the work be done by someone experienced in handling uncured paint. Any Cessna Dealer can accomplish this work.

Generally, the painted surfaces can be kept bright by washing with water and mild soap, followed by a rinse with water and drying with cloths or a chamois. Harsh or abrasive soaps or detergents which cause corrosion or scratches should never be used. Remove stubborn oil and grease with a cloth moistened with Stoddard solvent.

Waxing is unnecessary to keep the painted surfaces bright. However, if desired, the airplane may be waxed with a good automotive wax. A heavier coating of wax on the leading edges of the wings and tail and on the engine nose cap and propeller spinner will help reduce the abrasion encountered in these areas.

When the airplane is parked outside in cold climates and it is necessary to remove ice before flight, care should be taken to protect the painted surfaces during ice removal with chemical liquids. A 50-50 solution of isopropyl alcohol and water will satisfactorily remove ice accumulations without damaging the paint. A solution with more than 50% alcohol is harmful and should be avoided. While applying the de-icing solution, keep it away from the windshield and cabin windows since the alcohol will attack the plastic and may cause it to craze.

### **PROPELLER CARE**

Preflight inspection of propeller blades for nicks, and wiping them occasionally with an oily cloth to clean off grass and bug stains will assure long, trouble-free service. Small nicks on the propeller, particularly near the tips and on the leading edges, should be dressed out as soon as possible since these nicks produce stress concentrations, and if ignored, may result in cracks. Never use an alkaline cleaner on the blades; remove grease and dirt with carbon tetrachloride or Stoddard solvent.

### **ENGINE CARE**

The engine may be cleaned with Stoddard solvent, or equivalent, then dried thoroughly.

### **CAUTION**

Particular care should be given to electrical equipment before cleaning. Cleaning fluids should not be allowed to enter magnetos, starter, alternator and the like. Protect these components before saturating the engine with solvents. All other openings should also be covered before cleaning the engine assembly. Caustic cleaning solutions should be used cautiously and should always be properly neutralized after their use.

### **INTERIOR CARE**

To remove dust and loose dirt from the upholstery and carpet, clean the interior regularly with a vacuum cleaner.

Blot up any spilled liquid promptly with cleansing tissue or rags. Don't pat the spot; press the blotting material firmly and hold it for several seconds. Continue blotting until no more liquid is taken up. Scrape off sticky materials with a dull knife, then spot-clean the area.

Oily spots may be cleaned with household spot removers, used sparingly. Before using any solvent, read the instructions on the container and test it on an obscure place on the fabric to be cleaned. Never saturate the fabric with a volatile solvent; it may damage the padding and backing materials.

Soiled upholstery and carpet may be cleaned with foam-type detergent, used according to the manufacturer's instructions. To minimize wetting the fabric, keep the foam as dry as possible and remove it with a vacuum cleaner.

The plastic trim, headliner, instrument panel and control knobs need only be wiped off with a damp cloth. Oil and grease on the control wheel and control knobs can be removed with a cloth moistened with Stoddard solvent. Volatile solvents, such as mentioned in paragraphs on care of the windshield, must be never be used since they soften and craze the plastic.



# SECTION 9 SUPPLEMENTS (Optional Systems Description & Operating Procedures)

## TABLE OF CONTENTS

### Introduction

### Supplements:

Emergency Locator Transmitted (ELT) . . . . .	(4 pages)
Cessna 300 Nav/Com (Type RT-308C) . . . . .	(4 pages)
Cessna 300 Nav/Com (Type RT-328T) . . . . .	(6 pages)
Cessna 300 ADF (Type R-546E) . . . . .	(6 pages)
Cessna 300 Transponder (Type RT-359A) and Optional Encoding Altimeter (Type EA-401A) . . . . .	(6 pages)
Cessna 300 Transponder (Type RT-359A) and Optional Altitude Encoder (Blind) . . . . .	(6 pages)
Cessna 400 Transponder (Type RT-459A) and Optional Encoding Altimeter (Type EA-401A) . . . . .	(6 pages)
Cessna 400 Transponder (Type RT-459A) and Optional Altitude Encoder (Blind) . . . . .	(6 pages)
Cessna 400 Marker Beacon (Type R-402A) . . . . .	(4 pages)
Cessna 400 Glide Slope (Type R-443B) . . . . .	(4 pages)

## **INTRODUCTION**

This section consists of a series of supplements, each covering a single optional system which may be installed in the airplane. Each supplement contains a brief description, and when applicable, operating limitations, emergency and normal procedures, and performance. Other routinely installed items of optional equipment, whose function and operational procedures do not require detailed instructions, are discussed in Section 7.

## **SUPPLEMENT**

# **EMERGENCY LOCATOR TRANSMITTER (ELT)**

## **SECTION 1**

### **GENERAL**

The ELT consists of a self-contained dual-frequency radio transmitter and battery power supply, and is activated by an impact of 5g or more as may be experienced in a crash landing. The ELT emits an omnidirectional signal on the international distress frequencies of 121.5 and 243.0 MHz. (Some ELT units in export aircraft transmit only on 121.5 MHz.) General aviation and commercial aircraft, the FAA, and CAP monitor 121.5 MHz, and 243.0 MHz is monitored by the military. Following a crash landing, the ELT will provide line-of-sight transmission up to 100 miles at 10,000 feet. The duration of ELT transmissions is affected by ambient temperature. At temperatures of +21° to +54°C (+70° to +130°F), continuous transmission for 115 hours can be expected; a temperature of -40°C (-40°F) will shorten the duration to 70 hours.

The ELT is readily identified as a bright orange unit mounted behind the baggage compartment wall in the tailcone. To gain access to the unit, remove the baggage compartment wall. The ELT is operated by a control panel at the forward facing end of the unit (see figure 1).

## **SECTION 2**

### **LIMITATIONS**

There is no change to the airplane limitations when this equipment is installed.



COVER - Removable for access to battery.

FUNCTION SELECTOR SWITCH (3-position toggle switch):

ON - Activates transmitter instantly. Used for test purposes and if "g" switch is inoperative.

OFF - Deactivates transmitter. Used during shipping, storage and following rescue.

ARM- Activates transmitter only when "g" switch receives 5g or more impact.

ANTENNA RECEPTACLE - Connection to antenna mounted on top of the tailcone.

Figure 1. ELT Control Panel

## SECTION 3

### EMERGENCY PROCEDURES

Immediately after a forced landing where emergency assistance is required, the ELT should be utilized as follows.

(1) ENSURE ELT ACTIVATION: Turn a radio transceiver ON and select 121.5 MHz. If the ELT can be heard transmitting, it was activated by the "g" switch and is functioning properly. If no emergency tone is audible, gain access to the ELT and place the function se-

lector switch in the ON position.

(2) **PRIOR TO SIGHTING RESCUE AIRCRAFT:** Conserve airplane battery. Do not activate radio transceiver.

(3) **AFTER SIGHTING RESCUE AIRCRAFT:** Place ELT function selector switch in the OFF position, preventing radio interference. Attempt contact with rescue aircraft with the radio transceiver set to a frequency of 121.5 MHz. If no contact is established, return the function selector switch to ON immediately.

(4) **FOLLOWING RESCUE:** Place ELT function selector switch in the OFF position, terminating emergency transmissions.

## **SECTION 4**

### **NORMAL PROCEDURES**

As long as the function selector switch remains in the ARM position, the ELT automatically activates following an impact of 5g or more over a short period of time.

Following a lightning strike, or an exceptionally hard landing, the ELT may activate although no emergency exists. To check your ELT for inadvertent activation, select 121.5 MHz on your radio transceiver and listen for an emergency tone transmission. If the ELT can be heard transmitting, place the function selector switch in the OFF position and the tone should cease. Immediately place the function selector switch in the ARM Position to re-set the ELT for normal operation.

## **SECTION 5**

### **PERFORMANCE**

There is no change to the airplane performance data when this equipment is installed.



# **SUPPLEMENT**

## **CESSNA 300 NAV/COM**

### **(COM/VOR, No LOC - Type RT-308C)**

#### **SECTION 1**

#### **GENERAL**

The Cessna 300 Nav/Com (Type RT-308C), shown in Figure 1, consists of a panel-mounted receiver-transmitter (RT-308C) and a single needle course deviation indicator (IN-514R or IN-514B). The RT-308C Receiver-Transmitter includes a 360-channel VHF communication receiver-transmitter and a 160-channel VHF navigation receiver, both of which may be operated simultaneously.

The communication receiver-transmitter receives and transmits signals between 118.00 and 135.95 MHz in 50 kHz steps. The navigation receiver receives and interprets VHF omnidirectional range (VOR) signals between 108.00 and 117.95 MHz. Although localizer signals (all odd-tenth frequencies between 108.1 and 111.9 MHz) can also be received, the navigation receiver does not include the necessary circuits to interpret the signals for localizer indications. However, the audio portion of the localizer is audible so that flight information, such as that broadcast in certain areas on selected localizer frequencies by the Automatic Terminal Information Service (ATIS), may be heard.

All controls for the Cessna 300 Nav/Com (Type RT-308C), except the omni bearing selector (OBS), are mounted on the front panel of the receiver-transmitter. The course selector and the navigation indicators are included in the course deviation indicator. The communication receiver-transmitter and the navigation receiver are synthesizer-controlled and are tuned automatically when the frequency is selected. In addition, when two or more radios are installed, a transmitter selector switch and a speaker-phone selector switch are provided. Each control function is described in Figure 1.

#### **SECTION 2**

#### **LIMITATIONS**

There is no change to the airplane limitations when this avionic equipment is installed.

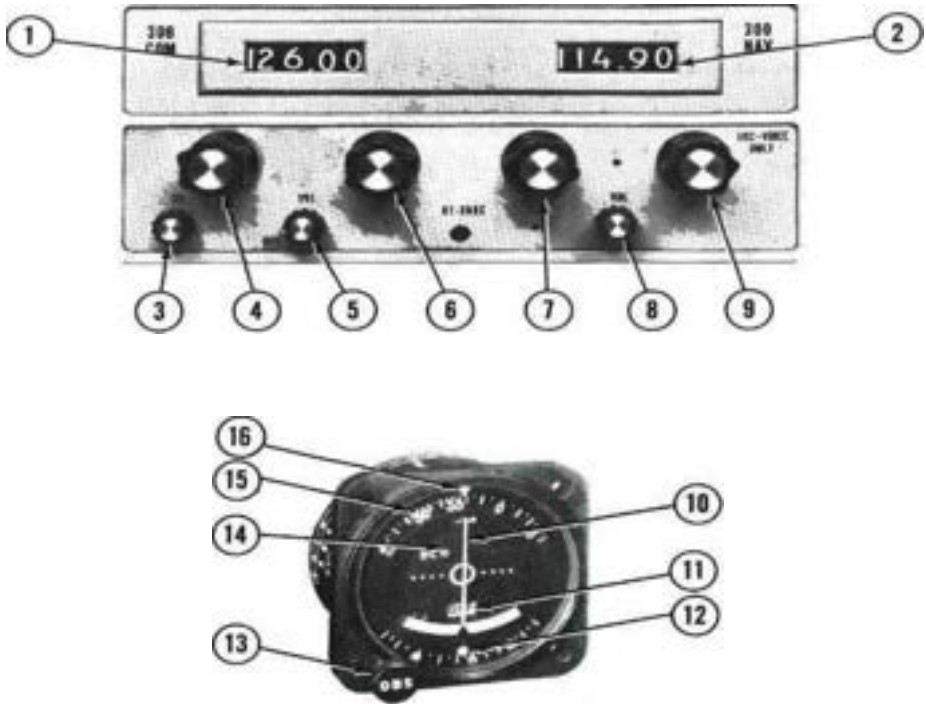

1. RECEIVER-TRANSMITTER FREQUENCY INDICATOR.
2. NAVIGATION RECEIVER FREQUENCY INDICATOR.
3. SQUELCH CONTROL - Used to adjust signal threshold necessary to activate communication receiver audio. Clockwise rotation increases background noise (decreases squelch action); counterclockwise rotation decreases background noise.
4. COMMUNICATION RECEIVER-TRANSMITTER MEGAHERTZ SELECTOR - Selects communication receiver-transmitter frequency in 1-MHz steps between 118 and 135 MHz.

Figure 1. Cessna 300 Nav/Com (Type RT-308C) - VOR only (Sheet 1 of 2)



5. OFF/ON VOLUME CONTROL - Turns complete set on and controls volume of audio from communication receiver. Clockwise rotation increases audio level.
6. COMMUNICATION RECEIVER-TRANSMITTER FRACTIONAL MEGAHERTZ SELECTOR - Selects communication receiver-transmitter fractional frequency in 0.05 MHz steps between 0.00 and 0.95 MHz.
7. NAVIGATION RECEIVER MEGAHERTZ SELECTOR - Selects navigation receiver frequency in 1-MHz steps between 108 and 117 MHz.
8. NAVIGATION RECEIVER VOLUME CONTROL - Controls volume of audio from navigation receiver only. Clockwise rotation increases audio level.
9. NAVIGATION RECEIVER FRACTIONAL MEGAHERTZ SELECTOR - Selects navigation receiver frequency in 0.05 MHz steps between 0.00 and 0.95 MHz.
10. COURSE DEVIATION POINTER - Indicates deviation from selected omni bearing.
11. OFF/TO-FROM (OMNI) INDICATOR - Operates only with VOR signal. "OFF" position (flag) indicates unreliable signal or no signal (shows OFF when localizer frequency is selected). When "OFF" position disappears, indicator shows whether selected course is "TO" or "FROM" VOR station.
12. RECIPROCAL COURSE INDEX - Indicates reciprocal of selected VOR course.
13. OMNI BEARING SELECTOR (OBS) - Selects desired course to or from a VOR station.
14. BACK COURSE (BC) INDICATOR LIGHT (On IN-514B Only) - Not used with this radio.
15. BEARING DIAL - Rotated by OBS to select course at index.
16. COURSE INDEX - Indicates selected VOR course.

Figure 1. Cessna 300 Nav/Com (Type RT-308C) - VOR only (Sheet 2 of 2)

## **SECTION 3**

### **EMERGENCY PROCEDURES**

There is no change to the airplane emergency procedures when this avionic equipment is installed.

## **SECTION 4**

### **NORMAL PROCEDURES**

#### COMMUNICATIONS TRANSCEIVER OPERATION:

- (1) OFF/VOL Control — TURN ON and adjust to desired listening level.
- (2) XMTR SEL Switch -- SET to desired transceiver.
- (3) SPEAKER/PHONE (or AUTO) Switch -- SET to desired mode.
- (4) COM Frequency Selector Knobs — SELECT desired operating frequency.
- (5) SQ Control — ROTATE counterclockwise to decrease background noise as required.
- (6) Mike Button:
  - a. To Transmit — DEPRESS and SPEAK into microphone.
  - b. To Receive -- RELEASE.

#### NAVIGATION RECEIVER OPERATION:

- (1) COM OFF/VOL Control -- TURN ON.
- (2) SPEAKER/PHONE (or AUTO) Switch -- SET to desired mode.
- (3) NAV Frequency Selector Knobs — SELECT desired operating frequency.
- (4) NAV VOL Control -- ADJUST to desired listening level.
- (5) OBS Knob — SELECT desired course.

## **SECTION 5**

### **PERFORMANCE**

There is no change to the airplane performance when this avionic equipment is installed. However, the installation of an externally mounted antenna or several related external antennas, will result in a minor reduction in cruise performance.

## SUPPLEMENT

# CESSNA 300 NAV/COM (720-Channel - Type RT-328T)

## SECTION 1 GENERAL

The Cessna 300 Nav/Com (Type RT-328T), shown in Figure 1, consists of a panel-mounted receiver-transmitter and a single- or dual-pointer remote course deviation indicator (CDI). The set includes a 720-channel VHF communication receiver-transmitter and a 200-channel VHF navigation receiver, both of which may be operated simultaneously.

The communication receiver-transmitter receives and transmits signals between 118.000 and 135.975 MHz in 25-kHz steps. The navigation receiver receives and interprets VHF omnidirectional and localizer signals between 108.00 and 117.95 MHz in 50-kHz steps. The communication receiver-transmitter and the navigation receiver are synthesizer-controlled and are tuned automatically when the frequency is selected.

A DME receiver-transmitter or a glide slope receiver, or both, may be interconnected with the Cessna 300 Nav/Com set for automatic selection of the associated DME or GS frequency. When a VOR frequency is selected on the Nav/Com, the associated VORTAC or VOR-DME station frequency will also be selected automatically; likewise, if a localizer frequency is selected, the associated glide slope frequency will be selected automatically.

All controls of the Cessna 300 Nav/Com, except the omni bearing selector knob (OBS), which is located on the course indicator, are mounted on the front panel of the receiver-transmitter. The course indicator includes either a single pointer and related OFF flag for VOR/LOC indication only, or dual pointers and related OFF flags for both VOR/LOC and glide slope indications. The course indicator also incorporates a back-course lamp (BC) which lights when optional back-course operation is selected. In addition, when two or more radios are installed, a transmitter selector switch and a speaker-phone selector switch are provided. Each control function is described in Figure 1.

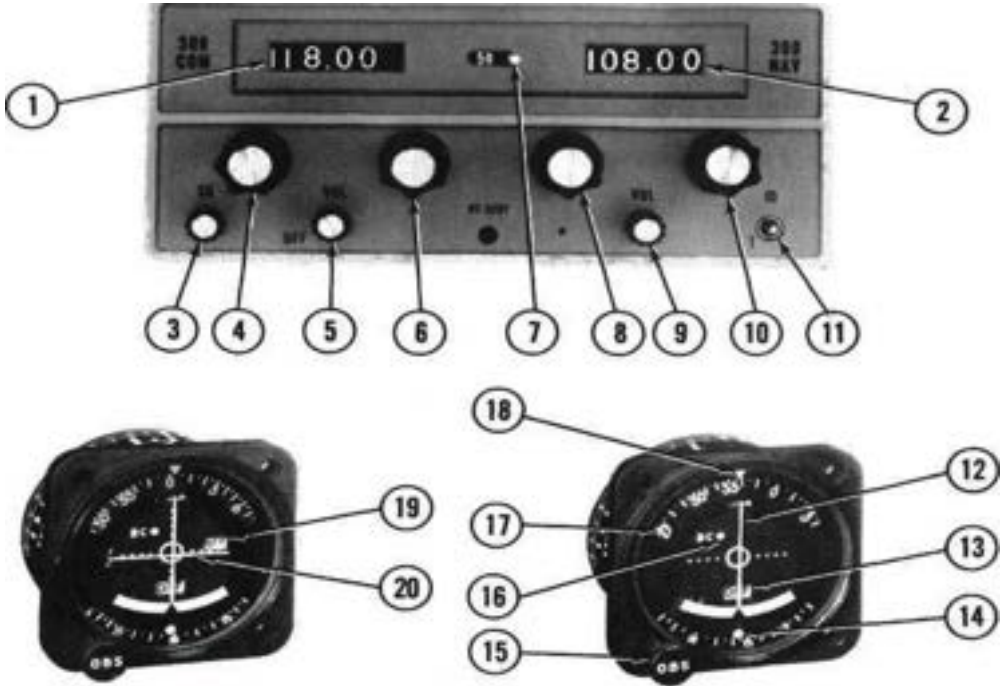

1. RECEIVER-TRANSMITTER FREQUENCY INDICATOR.
2. NAVIGATION RECEIVER FREQUENCY INDICATOR.
3. SQUELCH CONTROL - Used to adjust signal threshold necessary to activate communication receiver audio. Clockwise rotation increases background noise (decreases squelch action); counterclockwise rotation decreases background noise.
4. COMMUNICATION RECEIVER-TRANSMITTER MEGAHERTZ SELECTOR - Selects communication receiver-transmitter frequency in 1-MHz steps between 118 and 135 MHz.
5. OFF/ON VOLUME CONTROL - Turns set on and controls volume of audio from communications receiver.
6. COMMUNICATION RECEIVER-TRANSMITTER FRACTIONAL MEGAHERTZ SELECTOR - Selects communication receiver-transmitter fractional frequency in .05-MHz steps between .000 and .950 MHz or between .025 and .975 MHz depending on position of 50-25 MHz selector switch (7).

Figure 1. Cessna 300 Nav/Com (Type RT-328T) (Sheet 1 of 2)

7. 50-25 FRACTIONAL MHz SELECTOR SWITCH - In "50" position, enables communication whole MHz frequency readout to display and communication fractional MHz control to select fractional part of frequency in .05-MHz steps between .000 and .950 MHz. In "25" position, frequency display and coverage is in .05-MHz steps between .025 and .975.

NOTE

The third-decimal-place digit is not shown on the receiver-transmitter frequency readout.

8. NAVIGATION RECEIVER MEGAHERTZ SELECTOR - Selects navigation receiver frequency in 1-MHz steps between 108 and 117 MHz; simultaneously selects paired glide slope frequency or DME channel.
9. NAVIGATION RECEIVER VOLUME CONTROL - Controls volume of audio from navigation receiver only. Clockwise rotation increases audio level.
10. NAVIGATION RECEIVER FRACTIONAL MEGAHERTZ SELECTOR - Selects navigation receiver frequency in .05-MHz steps between .00 and .95 MHz; simultaneously paired glide slope frequency or DME channel.
11. COMBINED IDENTIFIER SIGNAL SELECTOR AND VOR SELF-TEST SELECTOR SWITCH (ID-T SWITCH) - With VOR or LOC station selected, in ED position, station identifier is audible; in center (unmarked) position, identifier is off; in T (momentary on) position, tests VOR navigation circuits.
12. COURSE DEVIATION POINTER - Indicates deviation from selected omni bearing or localizer centerline.
13. OFF/TO-FROM (OMNI) INDICATOR - Operates only with VOR or localizer signal. "OFF" position (flag) indicates unreliable signal. When "OFF" position disappears, indicator shows whether selected VOR course is "TO" or "FROM" the station (if LOC frequency is selected, indicator will only show "TO").
14. RECIPROCAL COURSE INDEX - Indicates reciprocal of selected VOR course.
15. OMNI BEARING SELECTOR (OBS) - Selects desired course to or from a VOR station.
16. BC - During LOC operation, when optional Back-Course operation is selected, amber lamp illuminates to alert the pilot that CDI indication is reversed.
17. BEARING DIAL - Rotated by OBS to select course at index.
18. COURSE INDEX - Indicates selected VOR course.
19. GLIDE SLOPE "OFF" FLAG - When visible, indicates unreliable glide slope signal or no glide slope signal. The flag disappears when a reliable glide slope signal is being received.
20. GLIDE SLOPE DEVIATION POINTER - Indicates deviation from normal glide slope.

**Figure 1.** Cessna 300 Nav/Com (Type RT-328T) (Sheet 2 of 2)

## **SECTION 2**

### **LIMITATIONS**

There is no change to the airplane limitations when this avionic equipment is installed. However, the pilot should be aware that on many Cessna airplanes equipped with the windshield mounted glide slope antenna, pilots should avoid use of 2700  $\pm$ 100 RPM (or 1800  $\pm$ 100 RPM with a three bladed propeller) during ILS approaches to avoid oscillations of the glide slope deviation pointer caused by propeller interference.

## **SECTION 3**

### **EMERGENCY PROCEDURES**

There is no change to the airplane emergency procedures when this avionic equipment is installed.

## **SECTION 4**

### **NORMAL PROCEDURES**

#### **COMMUNICATIONS TRANSCEIVER OPERATION:**

- (1) OFF/VOL Control — TURN ON and adjust to desired listening level.
- (2) XMTR SEL Switch — SET to desired transceiver.
- (3) SPEAKER PHONE (or AUTO) Switch -- SET to desired mode.
- (4) 50-25 Fractional MHz Selector Switch -- SELECT desired frequency (does not affect navigation frequencies).
- (5) COM Frequency Selector Knobs — SELECT desired operating frequency.
- (6) SQ Control — ROTATE counterclockwise to decrease background noise as required.
- (7) Mike Button:
  - a. To Transmit — DEPRESS and SPEAK into microphone.
  - b. To Receive — RELEASE.

#### **NAVIGATION RECEIVER OPERATION:**

- (1) COM OFF/VOL Control - TURN ON.
- (2) SPEAKER/PHONE (or AUTO) Switch -- SET to desired mode.
- (3) NAV Frequency Selector Knobs — SELECT desired operating frequency.

- (4) NAV VOL Control -- ADJUST to desired audio level.
- (5) ID-T Switch:
  - a. To Identify Station — SET to ID to hear navigation station identifier (Morse Code) signal.
  - b. To Filter Out Station Identifier Signal -- SET to CENTER (unmarked) position to include filter in audio circuit.
- (6) OBS Knob — SELECT desired course.

TO SELF TEST VOR NAVIGATION CIRCUITS:

- (1) COM OFF/VOL Control -- TURN ON.
- (2) NAV Frequency Selector Switches — SELECT usable VOR station signal.
- (3) OBS Knob — SET for 0° course at index; CDI pointer centers or deflects left or right, depending on bearing of signal; OFF/TO-FROM indicator shows TO or FROM.
- (4) ID-T Switch -- PRESS to T and HOLD at T; CDI pointer should center and OFF/TO-FROM indicator should show FROM.
- (5) OBS Knob — TURN to displace course approximately 10° to either side of 0° (while holding ID-T switch at T); CDI pointer should deflect full scale in direction corresponding to course displacement. OFF/TO-FROM indicator should still show FROM.

NOTE

This test does not fulfill the requirements of FAR 91. 25.

## SECTION 5

### PERFORMANCE

There is no change to the airplane performance when this avionic equipment is installed. However, the installation of an externally mounted antenna or several related external antennas, will result in a minor reduction in cruise performance.





# **SUPPLEMENT**

## **CESSNA 300 ADF**

### **(Type R-546E)**

## **SECTION 1**

### **GENERAL**

The Cessna 300 ADF is a panel-mounted, digitally tuned automatic direction finder. It is designed to provide continuous 1 kHz digital tuning in the frequency range of 200 kHz to 1,699 kHz and eliminates the need for mechanical band switching. The system is comprised of a receiver, loop antenna, bearing indicator and a sense antenna. In addition, when two or more radios are installed, speaker-phone selector switches are provided. Each control function is described in Figure 1.

The Cessna 300 ADF can be used for position plotting and homing procedures, and for aural reception of amplitude-modulated (AM) signals.

With the function selector knob at ADF, the Cessna 300 ADF provides a visual indication, on the bearing indicator, of the bearing to the transmitting station relative to the nose of the airplane. This is done by combining signals from the sense antenna with signals from the loop antenna.

With the function selector knob at REC, the Cessna 300 ADF uses only the sense antenna and operates as a conventional low-frequency receiver.

The Cessna 300 ADF is designed to receive transmission from the following radio facilities: commercial broadcast stations, low-frequency range stations, FAA radio beacons, and ILS compass locatorSc

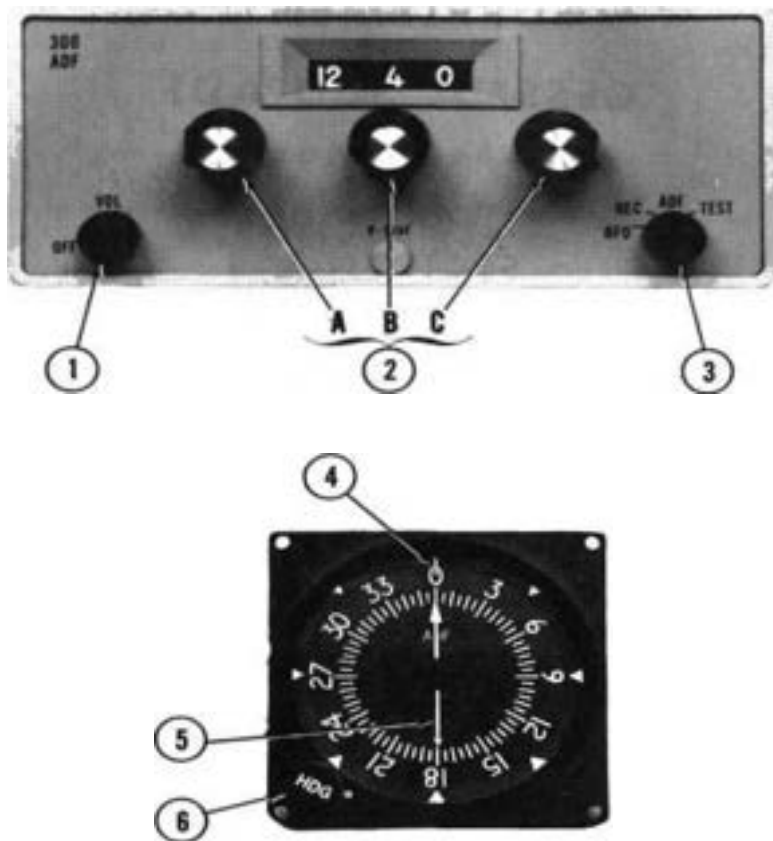

**OFF/VOL CONTROL** - Controls primary power and audio output level. Clockwise rotation from OFF position applies primary power to receiver; further clockwise rotation increases audio level

**FREQUENCY SELECTORS** - Knob (A) selects 100-kHz increments of receiver frequency, knob (B) selects 10-kHz increments, and knob (C) selects 1-kHz increments.

Figure 1. Cessna 300 ADF Operating Controls and Indicators (Sheet 1 of 2)

3. FUNCTION SWITCH:

BFO: Selects operation as communication receiver using only sense antenna and activates 1000-Hz tone beat frequency oscillator to permit coded identifier of stations transmitting keyed CW signals (Morse Code) to be heard.

REC: Selects operation as standard communication receiver using only sense antenna.

ADF: Set operates as automatic direction finder using loop and sense antennas.

TEST: Momentary-on position used during ADF operation to test bearing reliability. When held in TEST position, slews indicator pointer clockwise; when released, if bearing is reliable, pointer returns to original bearing position.

4. INDEX (ROTATABLE CARD) - Indicates relative, magnetic, or true heading of aircraft, as selected by HDG control.
5. POINTER - Indicates station bearing in degrees of azimuth, relative to the nose of the aircraft. When heading control is adjusted, indicates relative, magnetic, or true bearing of radio signal.
6. HEADING CONTROL (HDG) - Rotates card to set in relative, magnetic, or true bearing information.

## **SECTION 2**

### **LIMITATIONS**

There is no change to the airplane limitations when this avionic equipment is installed.

## **SECTION 3**

### **EMERGENCY PROCEDURES**

There is no change to the airplane emergency procedures when this avionic equipment is installed.

## **SECTION 4**

### **NORMAL PROCEDURES**

#### **TO OPERATE AS A COMMUNICATIONS RECEIVER ONLY:**

- (1) OFF/VOL Control -- ON.
- (2) Function Selector Knob -- REC.
- (3) Frequency Selector Knobs — SELECT operating frequency.
- (4) ADF SPEAKER/PHONE Switch -- SELECT speaker or phone position as desired.
- (5) VOL Control -- ADJUST to desired listening level.

#### **TO OPERATE AS AN AUTOMATIC DIRECTION FINDER:**

- (1) OFF/VOL Control -- ON.
- (2) Frequency Selector Knobs — SELECT operating frequency.
- (3) ADF SPEAKER/PHONE Switch — SELECT speaker or phone position.
- (4) Function Selector Knob — ADF position and note relative bearing on indicator.
- (5) VOL Control — ADJUST to desired listening level.

#### **TO TEST RELIABILITY OF AUTOMATIC DIRECTION FINDER:**

- (1) Function Selector Knob — ADF position and note relative bearing on indicator.
- (2) Function Selector Knob — TEST position and observe that pointer moves away from relative bearing at least 10 to 20 degrees.
- (3) Function Selector Knob — ADF position and observe that pointer returns to same relative bearing as in step (1).

TO OPERATE BFO:

- (1) OFF/VOL Control -- ON.
- (2) Function Selector Knob — BFO.
- (3) Frequency Selector Knobs — SELECT operating frequency.
- (4) ADF SPEAKER/PHONE Switch — SELECT speaker or phone position.
- (5) VOL Control — ADJUST to desired listening level.

NOTE

A 1000-Hz tone is heard in the audio output when a CW signal (Morse Code) is tuned in properly.

## **SECTION 5**

### **PERFORMANCE**

There is no change to the airplane performance when this avionic equipment is installed. However, the installation of an externally mounted antenna or several related external antennas, will result in a minor reduction in cruise performance.



**SUPPLEMENT**

**CESSNA 300 TRANSPONDER**  
**(Type RT-359A)**  
**AND**  
**OPTIONAL ENCODING**  
**(Type EA-401A)**

**SECTION 1**  
**GENERAL**

The Cessna 300 Transponder (Type RT-359A), shown in Figure 1, is the airborne component of an Air Traffic Control Radar Beacon System (ATCRBS). The transponder enables the ATC ground controller to "see" and identify the aircraft, while in flight, on the control center's radar-scope more readily.

The Cessna 300 Transponder consists of a panel-mounted unit and an externally-mounted antenna. The transponder receives interrogating pulse signals on 1030 MHz and transmits coded pulse-train reply signals on 1090 MHz. It is capable of replying to Mode A (aircraft identification) and Mode C (altitude reporting) interrogations on a selective reply basis on any of 4,096 information code selections. When an optional panel-mounted EA-401A Encoding Altimeter (not part of a standard 300 Transponder system) is included in the avionic configuration, the transponder can provide altitude reporting in 100-foot increments between -1000 and +35,000 feet.

All Cessna 300 Transponder operating controls, with the exception of the optional altitude encoder's altimeter setting knob, are located on the front panel of the unit. The altimeter setting knob is located on the encoding altimeter. Functions of the operating controls are described in Figure 1.

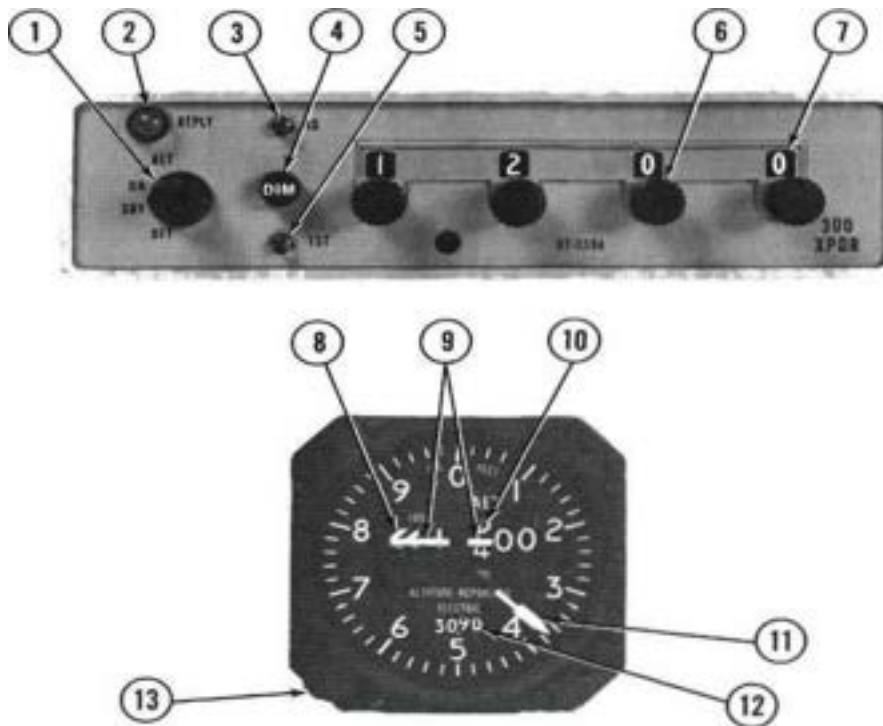

1. **FUNCTION SWITCH** - Controls application of power and selects transponder operating mode, as follows:
  - OFF - Turns set off.
  - SBY - Turns set on for equipment warm-up.
  - ON - Turns set on and enables transponder to transmit Mode A (aircraft identification) reply pulses.
  - ALT - Turns set on and enables transponder to transmit either Mode A (aircraft identification) reply pulses or Mode C (altitude reporting) pulses selected automatically by the interrogating signal.
2. **REPLY LAMP** - Lamp flashes to indicate transmission of reply pulses; glows steadily to indicate transmission of IDENT pulse or satisfactory self-test operation. (Reply Lamp will also glow steadily during initial warm-up period. )

Figure 1. Cessna 300 Transponder and Encoding Altimeter (Sheet 1 of 2)



3. IDENT (ID) SWITCH - When depressed, selects special pulse identifier to be transmitted with transponder reply to effect immediate identification of aircraft on ground controllers display. (Reply Lamp will glow steadily during duration of IDENT pulse transmission.)
4. DIMMER (DIM) CONTROL - Allows pilot to control brilliance of reply lamp.
5. SELF-TEST (TST) SWITCH — When depressed, causes transponder to generate a self-interrogating signal to provide a check of transponder operation. (Reply Lamp will glow steadily to verify self test operation.)
6. REPLY-CODE SELECTOR KNOBS (4) - Select assigned Mode A reply code.
7. REPLY-CODE INDICATORS (4) - Display selected Mode A reply code.
8. 1000-FOOT DRUM TYPE INDICATOR - Provides digital altitude readout in 1000-foot increments between -1000 feet and +35, 000 feet. When altitude is below 10, 000 feet, a diagonally striped flag appears in the 10, 000 foot window.
9. OFF INDICATOR WARNING FLAG - Flag appears across altitude readout when power is removed from the altimeter to indicate that readout is not reliable.
10. 100-FOOT DRUM TYPE INDICATOR - Provides digital altitude readout in 100-foot increments between 0 feet and 1000 feet.
11. 20-FOOT INDICATOR NEEDLE - Indicates altitude in 20-foot increments between 0 feet and 1000 feet.
12. ALTIMETER SETTING SCALE - DRUM TYPE - Indicates selected altimeter setting in the range of 27. 9 to 31. 0 inches of mercury on the standard altimeter or 950 to 1050 millibars on the optional altimeter.
13. ALTIMETER SETTING KNOB - Dials in desired altimeter setting in the range of 27. 9 to 31.0 inches of mercury on the standard altimeter or 950 to 1050 millibars on the optional altimeter.

Figure 1. Cessna 300 Transponder and Encoding Altimeter (Sheet 2 of 2)

## **SECTION 2**

### **LIMITATIONS**

There is no change to the airplane limitations when this avionic equipment is installed.

## **SECTION 3**

### **EMERGENCY PROCEDURES**

TO TRANSMIT AN EMERGENCY SIGNAL:

- (1) Function Switch — ON.
- (2) Reply-Code Selector Knobs — SELECT 7700 operating code.
- (3) ID Switch — DEPRESS then RELEASE to effect immediate identification of aircraft on ground controller's display.

TO TRANSMIT A SIGNAL REPRESENTING LOSS OF ALL COMMUNICATIONS (WHEN IN A CONTROLLED ENVIRONMENT):

- (1) Function Switch — ON.
- (2) Reply-Code Selector Knobs — SELECT 7700 operating code for 1 minute; then SELECT 7600 operating code for 15 minutes and then REPEAT this procedure at same intervals for remainder of flight.
- (3) ID Switch — DEPRESS then RELEASE at intervals to effect immediate identification of aircraft on ground controller's display.

## **SECTION 4**

### **NORMAL PROCEDURES**

BEFORE TAKEOFF:

- (1) Function Switch — SBY.

TO TRANSMIT MODE A (AIRCRAFT IDENTIFICATION) CODES IN FLIGHT:

- (1) Off Indicator Warning Flag — VERIFY that flag is out of view on encoding altimeter.

- (2) Reply-Code Selector Knobs — SELECT assigned code.
- (3) Function Switch — ON.
- (4) DIM Control -- ADJUST light brilliance of reply lamp.

NOTE

During normal operation with function switch in ON position, reply lamp flashes indicating transponder replies to interrogations.

- (5) ID Button — DEPRESS momentarily when instructed by ground controller to "squawk IDENT" (reply lamp will glow steadily, indicating IDENT operation).

TO TRANSMIT MODE C (ALTITUDE REPORTING) CODES IN FLIGHT:

- (1) Off Indicator Warning Flag ~ VERIFY that flag is out of view on encoding altimeter.
- (2) Altitude Encoder Altimeter Setting Knob - SET IN assigned local altimeter setting.
- (3) Reply-Code Selector Knobs — SELECT assigned code.
- (4) Function Switch — ALT.

NOTE

When directed by ground controller to "stop altitude squawk", turn Function Switch to ON for Mode A operation only.

NOTE

Pressure altitude is transmitted by the transponder for altitude squawk and conversion to indicated altitude is done in ATC computers. Altitude squawked will only agree with indicated altitude when the local altimeter setting in use by the ground controller is set in the encoding altimeter.

- (5) DIM Control - ADJUST light brilliance of reply lamp.

TO SELF-TEST TRANSPONDER OPERATION:

CO Function Switch — SBY and wait 30 seconds for equipment to warm-up.

- (2) Function Switch - ON or ALT.

- (3) TST Button -- DEPRESS and HOLD (reply lamp should light with full brilliance regardless of DIM control setting).
- (4) TST Button — Release for normal operation.

## **SECTION 5**

### **PERFORMANCE**

There is no change to the airplane performance when this avionic equipment is installed. However, the installation of an externally mounted antenna or several related external antennas, will result in a minor reduction in cruise performance.

# **SUPPLEMENT**

## **CESSNA 300 TRANSPONDER**

### **(Type RT-359A)**

## **AND**

## **OPTIONAL ALTITUDE ENCODER (BLIND)**

### **SECTION 1**

#### **GENERAL**

The Cessna 300 Transponder (Type RT-359A), shown in Figure 1, is the airborne component of an Air Traffic Control Radar Beacon System (ATCRBS). The transponder enables the ATC ground controller to "see" and identify the aircraft, while in flight, on the control center's radar scope more readily.

The Cessna 300 Transponder system consists of a panel-mounted unit and an externally-mounted antenna. The transponder receives interrogation pulse signals on 1030 MHz and transmits pulse-train reply signals on 1090 MHz. The transponder is capable of replying to Mode A (aircraft identification) and also Mode C (altitude reporting) when coupled to an optional altitude encoder system. The transponder is capable of replying on both modes of interrogation on a selective reply basis on any of 4,096 information code selections. The optional altitude encoder system (not part of a standard 300 Transponder system) required for Mode C (altitude reporting) operation consists of a completely independent remote-mounted digitizer that is connected to the static system and supplies encoded altitude information to the transponder. When the altitude encoder system is coupled to the 300 Transponder system, altitude reporting capabilities are available in 100-foot increments between -1000 and +20,000 feet.

All Cessna 300 Transponder operating controls are located on the front panel of the unit. Functions of the operating controls are described in figure 1.

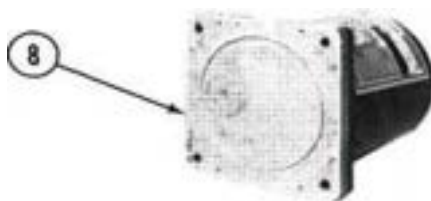
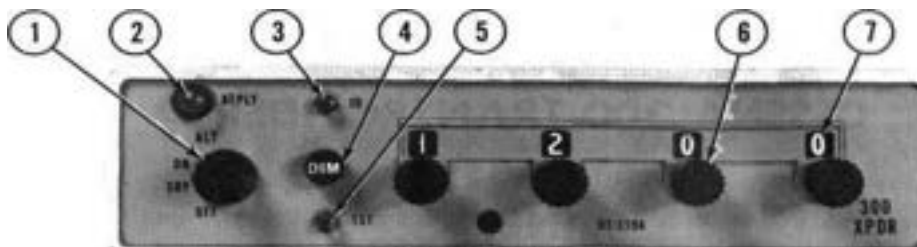

1. **FUNCTION SWITCH** - Controls application of power and selects transponder operating mode as follows:
  - OFF - Turns set off.
  - SBY - Turns set on for equipment warm-up or standby power
  - ON - Turns set on and enables transponder to transmit Mode A (aircraft identification) reply pulses.
  - ALT - Turns set on and enables transponder to transmit either Mode A (aircraft identification) reply pulses or Mode C (altitude reporting) pulses selected automatically by the interrogating signal.
2. **REPLY LAMP** - Lamp flashes to indicate transmission of reply pulses; glows steadily to indicate transmission of IDENT pulse or satisfactory self-test operation. (Reply lamp will also glow steadily during initial warm-up period.)

Figure 1. Cessna 300 Transponder and Altitude Encoder (Blind)  
(Sheet 1 of 2)

3. IDENT (ID) SWITCH - When depressed, selects special pulse identifier to be transmitted with transponder reply to effect immediate identification of aircraft on ground controllers display. (Reply lamp will glow steadily during duration of IDENT pulse transmission.)
4. DIMMER (DIM) CONTROL - Allows pilot to control brilliance of reply lamp.
5. SELF-TEST (TST) SWITCH - When depressed, causes transponder to generate a self-interrogating signal to provide a check of transponder operation. (Reply lamp will glow steadily to verify self-test operation.)
6. REPLY-CODE SELECTOR KNOBS (4) - Select assigned Mode A reply code.
7. REPLY-CODE INDICATORS (4) - Display selected Mode A reply code.
8. REMOTE-MOUNTED DIGITIZER - Provides an altitude reporting code range of -1000 feet up to the airplane's maximum service ceiling.

Figure 1. Cessna 300 Transponder and Altitude Encoder (Blind)  
(Sheet 2 of 2)

## **SECTION 2**

### **LIMITATIONS**

There is no change to the airplane limitations when this avionic equipment is installed. However, a placard labeled "ALTITUDE ENCODER EQUIPPED" must be installed near the altimeter.

## **SECTION 3**

### **EMERGENCY PROCEDURES**

TO TRANSMIT AN EMERGENCY SIGNAL:

- (1) Function Switch — ON.
- (2) Reply-Code Selector Knobs — SELECT 7700 operating code.
- (3) ID Switch - DEPRESS then RELEASE to effect immediate identification of aircraft on ground controllers display.

TO TRANSMIT A SIGNAL REPRESENTING LOSS OF ALL COMMUNICATIONS (WHEN IN A CONTROLLED ENVIRONMENT):

- (1) Function Switch — ON.
- (2) Reply-Code Selector Knobs - SELECT 7700 operating code for 1 minute; then SELECT 7600 operating code for 15 minutes and then REPEAT this procedure at same intervals for remainder of flight.
- (3) ID Switch - DEPRESS then RELEASE at intervals to effect immediate identification of aircraft on ground controller's display.

## **SECTION 4**

### **NORMAL PROCEDURES**

BEFORE TAKEOFF:

- (1) Function Switch — SBY.

TO TRANSMIT MODE A (AIRCRAFT IDENTIFICATION) CODES IN FLIGHT

- (1) Reply-Code Selector Knobs — SELECT assigned code.



- (2) Function Switch — ON.
- (3) DIM Control — -ADJUST light brilliance of reply lamp.

NOTE

During normal operation with function switch in ON position, reply lamp flashes indicating transponder replies to interrogations.

- (4) ID Button — DEPRESS momentarily when instructed by ground controller to "squawk IDENT" (reply lamp will glow steadily, indicating IDENT operation).

TO TRANSMIT MODE C (ALTITUDE REPORTING) CODES IN FLIGHT:

- (1) Reply-Code Selector Knobs — SELECT assigned code.
- (2) Function Switch -- ALT.

NOTE

When directed by ground controller to "stop altitude squawk", turn Function Switch to ON for Mode A operation only.

NOTE

Pressure altitude is transmitted by the transponder for altitude squawk and conversion to indicated altitude is done in ATC computers. Altitude squawked will only agree with indicated altitude when the local altimeter setting in use by the ground controller is set in the aircraft altimeter.

- (3) DIM Control — ADJUST light brilliance of reply lamp.

TO SELF-TEST TRANSPONDER OPERATION:

- (1) Function Switch — SBY and wait 30 seconds for equipment to warm-up.
- (2) Function Switch — ON or ALT.
- (3) TST Button ~ DEPRESS (reply lamp should light brightly regardless of DIM control setting).
- (4) TST Button — Release for normal operation.

## **SECTION 5**

### **PERFORMANCE**

There is no change to the airplane performance when this avionic equipment is installed. However, the installation of an externally mounted antenna or several related external antennas, will result in a minor reduction in cruise performance.

**SUPPLEMENT**

**CESSNA 400 TRANSPONDER**  
**(Type RT-459A)**  
**AND**  
**OPTIONAL ENCODING ALTIMETER**  
**(Type EA-401A)**

**SECTION 1**

**GENERAL**

The Cessna 400 Transponder (Type 459A), shown in Figure 1, is the airborne component of an Air Traffic Control Radar Beacon System (ATCRBS). The transponder enables the ATC ground controller to "see" and identify the aircraft, while in flight, on the control center's radar scope more readily.

The 400 Transponder consists of a panel-mounted unit and an externally-mounted antenna. The transponder receives interrogating pulse signals on 1030 MHz and transmits coded pulse-train reply signals on 1090 MHz. It is capable of replying to Mode A (aircraft identification) and Mode C (altitude reporting) interrogations on a selective reply basis on any of 4,096 information code selections. When an optional panel mounted EA-401A Encoding Altimeter (not part of 400 Transponder System) is included in the avionic configuration, the transponder can provide altitude reporting in 100-foot increments between -1000 and +35,000 feet.

All Cessna 400 Transponder operating controls, with the exception of the optional altitude encoder's altimeter setting knob, are located on the front panel of the unit. The altimeter setting knob is located on the encoding altimeter. Functions of the operating controls are described in figure 1.

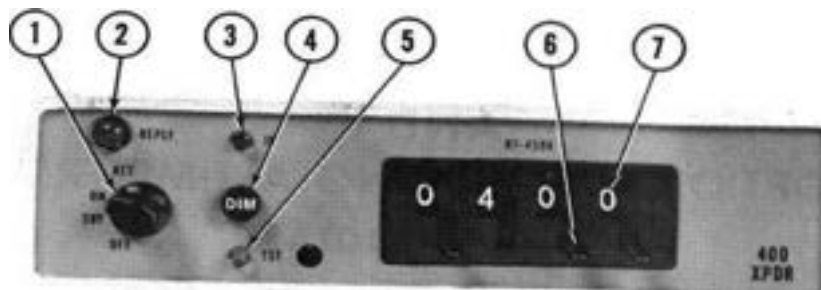

Figure 1. Cessna 400 Transponder and Encoding Altimeter Operating Controls (Sheet 1 of 2)

1. FUNCTION SWITCH - Controls application of power and selects transponder operating mode as follows:
  - OFF - Turns set off.
  - SBY - Turns set on for equipment warm-up or standby power.
  - ON - Turns set on and enables transponder to transmit Mode A (aircraft identification) reply pulses.
  - ALT - Turns set on and enables transponder to transmit either Mode A (aircraft identification) reply pulses or Mode C (altitude reporting) pulses selected automatically by the interrogating signal.
2. REPLY LAMP - Lamp flashes to indicate transmission of reply pulses; glows steadily to indicate transmission of IDENT pulse or satisfactory self-test operation. (Reply Lamp will also glow steadily during initial warm-up period.)
3. IDENT (*ID*) SWITCH - When depressed, selects special pulse identifier to be transmitted with transponder reply to effect immediate identification of aircraft on ground controller's display. (Reply Lamp will glow steadily during duration of IDENT pulse transmission.)
4. DIMMER (DIM) CONTROL - Allows pilot to control brilliance of Reply Lamp.
5. SELF-TEST (TST) SWITCH - When depressed, causes transponder to generate a self-interrogating signal to provide a check of transponder operation. (Reply Lamp will glow steadily to verify self test operation.)
6. REPLY-CODE SELECTOR SWITCHES (4) - Select assigned Mode A Reply Code.
7. REPLY Y-CODE INDICATORS (4) - Display selected Mode A Reply Code.
8. 1000-FOOT DRUM TYPE INDICATOR - Provides digital altitude readout in 1000-foot increments between -1000 feet and +35,000 feet. When altitude is below 10,000 feet, a diagonally striped flag appears in the 10, 000-foot window.
9. OFF INDICATOR WARNING FLAG - Flag appears across altitude readout when power is removed from altimeter to indicate that readout is not reliable.
10. 100-FOOT DRUM TYPE INDICATOR - Provides digital altitude readout in 100-foot increments between 0 feet and 1000 feet.
11. 20-FOOT INDICATOR NEEDLE - Indicates altitude in 20-foot increments between 0 feet and 1000 feet.
12. ALTIMETER SETTING SCALE - DRUM TYPE - Indicates selected altimeter setting in the range of 28. 1 to 30. 99 inches of mercury on the standard altimeter or 946 to 1049 millibars on the optional altimeter.
13. ALTIMETER SETTING KNOB - Dials in desired altimeter setting in the range of 28. 1 to 30. 99 inches of mercury on standard altimeter or 946 to 1049 millibars on the optional altimeter.

Figure 1. Cessna 400 Transponder and Encoding Altimeter Operating Controls (Sheet 2 of 2)

## **SECTION 2**

### **LIMITATIONS**

There is no change to the airplane limitations when this avionic equipment is installed.

## **SECTION 3**

### **EMERGENCY PROCEDURES**

TO TRANSMIT AN EMERGENCY SIGNAL:

- (1) Function Switch — ON.
- (2) Reply-Code Selector Switches — SELECT 7700 operating code.
- (3) ID Switch -- DEPRESS then RELEASE to effect immediate identification of aircraft on ground controller's display.

TO TRANSMIT A SIGNAL REPRESENTING LOSS OF ALL COMMUNICATIONS (WHEN IN A CONTROLLED ENVIRONMENT):

- (1) Function Switch — ON.
- (2) Reply-Code Selector Switches — SELECT 7700 operating code for 1 minute; then SELECT 7600 operating code for 15 minutes and then REPEAT this procedure at same intervals for remainder of flight.
- (3) ID Switch - DEPRESS then RELEASE at intervals to effect immediate identification of aircraft on ground controller's display.

## **SECTION 4**

### **NORMAL PROCEDURES**

BEFORE TAKEOFF:

- (1) Function Switch - SBY.

TO TRANSMIT MODE A (AIRCRAFT IDENTIFICATION) CODES IN FLIGHT:

- (1) Off Indicator Warning Flag — VERIFY that flag is out of view on encoding altimeter.

- (2) Reply-Code Selector Switches — SELECT assigned code.
- (3) Function Switch — ON.
- (4) DIM Control -- ADJUST light brilliance of reply lamp.

NOTE

During normal operation with function switch in ON position, REPLY lamp flashes indicating transponder replies to interrogations.

- (5) ID Button — DEPRESS momentarily when instructed by ground controller to "squawk IDENT" (REPLY lamp will glow steadily, indicating IDENT operation).

TO TRANSMIT MODE C (ALTITUDE REPORTING) CODES IN FLIGHT:

- (1) Off Indicator Warning Flag -- VERIFY that flag is out of view on encoding altimeter.
- (2) Altitude Encoder Altimeter Setting Knob - SET IN assigned local altimeter setting.
- (3) Reply-Code Selector Switches -- SELECT assigned code.
- (4) Function Switch -- ALT.

NOTE

When directed by ground controller to "stop altitude squawk", turn Function Switch to ON for Mode A operation only.

NOTE

Pressure altitude is transmitted by the transponder for altitude squawk and conversion to indicated altitude is done in ATC computers. Altitude squawked will only agree with indicated altitude when the local altimeter setting in use by the ground controller is set in the encoding altimeter.

- (5) DIM Control -- ADJUST light brilliance of reply lamp.

SELF-TEST TRANSPONDER OPERATION:

- (1) Function Switch — SBY and wait 30 seconds for equipment to warm-up.

- (2) Function Switch -- ON or ALT.
- (3) TST Button - DEPRESS and HOLD (Reply lamp should light with full brilliance regardless of DIM control setting).
- (4) TST Button — Release for normal operation.

## **SECTION 5**

### **PERFORMANCE**

There is no change to the airplane performance when this avionic equipment is installed. However, the installation of an externally mounted antenna or several related external antennas, will result in a minor reduction in cruise performance.



## **SUPPLEMENT**

# **CESSNA 400 TRANSPONDER (Type RT-459A) AND OPTIONAL ALTITUDE ENCODER (BLIND)**

## **SECTION 1 GENERAL**

The Cessna 400 Transponder (Type RT-459A), shown in Figure 1, is the airborne component of an Air Traffic Control Radar Beacon System (ATCRBS). The transponder enables the ATC ground controller to "see" and identify the aircraft, while in flight, on the control center's radar-scope more readily.

The Cessna 400 Transponder system consists of a panel-mounted unit and an externally-mounted antenna. The transponder receives interrogating pulse signals on 1030 MHz and transmits pulse-train reply signals on 1090 MHz. The transponder is capable of replying to Mode A (aircraft identification) and also to Mode C (altitude reporting) when coupled to an optional altitude encoder system. The transponder is capable of replying on both modes of interrogation on a selective reply basis on any of 4,096 information code selections. The optional altitude encoder system (not part of a standard 400 Transponder system) required for Mode C (altitude reporting) operation, consists of a completely independent remote-mounted digitizer that is connected to the static system and supplies encoded altitude information to the transponder. When the altitude encoder system is coupled to the 400 Transponder system, altitude reporting capabilities are available in 100-foot increments between -1000 feet and the airplane's Maximum service ceiling.

All Cessna 400 Transponder operating controls are located on the front panel of the unit. Functions of the operating controls are described in Figure 1.

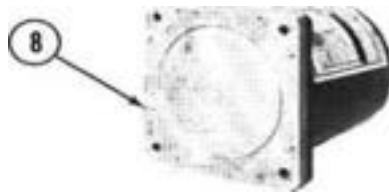
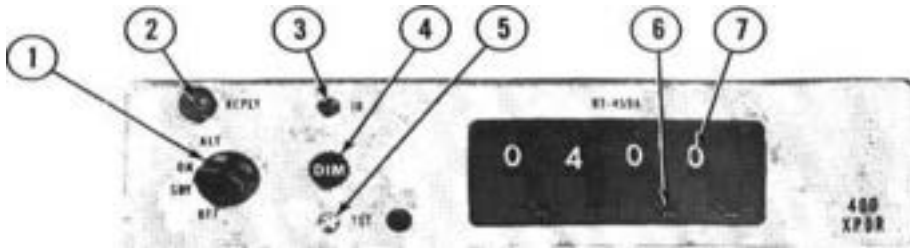

1. **FUNCTION SWITCH** - Controls application of power and selects transponder operating mode as follows:
  - OFF - Turns set off.
  - SBY - Turns set on for equipment warm-up or standby power.
  - ON - Turns set on and enables transponder to transmit Mode A (aircraft identification) reply pulses.
  - ALT - Turns set on and enables transponder to transmit either Mode A (aircraft identification) reply pulses or Mode C (altitude reporting) pulses selected automatically by the interrogating signal.
2. **REPLY LAMP** - Lamp flashes to indicate transmission of reply pulses; glows steadily to indicate transmission of IDENT pulse or satisfactory self-test operation. (Reply lamp will also glow steadily during initial warm-up period.)

Figure 1. Cessna 400 Transponder and Altitude Encoder (Blind)  
(Sheet 1 of 2)

3. IDENT (ID) SWITCH - When depressed, selects special pulse identifier to be transmitted with transponder reply to effect immediate identification of aircraft on ground controller's display. (Reply lamp will glow steadily during duration of IDENT pulse transmission.)
4. DIMMER (DIM) CONTROL - Allows pilot to control brilliance of reply lamp.
5. SELF-TEST (TST) SWITCH - When depressed, causes transponder to generate a self-interrogating signal to provide a check of transponder operation. (Reply lamp will glow steadily to verify self-test operation.)
6. REPLY-CODE SELECTOR SWITCHES (4) - Select assigned Mode A reply code.
7. REPLY-CODE INDICATORS (4) - Display selected Mode A reply code.
8. REMOTE-MOUNTED DIGITIZER - Provides an altitude reporting code range of -1000 feet up to the airplane's maximum service ceiling.

Figure 1. Cessna 400 Transponder and Altitude Encoder (Blind)  
(Sheet2 of 2)

## **SECTION 2**

### **LIMITATIONS**

There is no change to the airplane limitations when this avionics equipment is installed. However, a placard labeled "ALTITUDE ENCODER EQUIPPED" must be installed near the altimeter.

## **SECTION 3**

### **EMERGENCY PROCEDURES**

TO TRANSMIT AN EMERGENCY SIGNAL:

- (1) Function Switch — ON.
- (2) Reply-Code Selector Switches — SELECT 7700 operating code.
- (3) ID Switch — DEPRESS then RELEASE to effect immediate identification of aircraft on ground controller's display.

TO TRANSMIT A SIGNAL REPRESENTING LOSS OF ALL COMMUNICATIONS (WHEN IN A CONTROLLED ENVIRONMENT):

- (1) Function Switch — ON.
- (2) Reply-Code Selector Switches — SELECT 7700 operating code for 1 minute; then SELECT 7600 operating code for 15 minutes and then REPEAT this procedure at same intervals for remainder of flight.
- (3) ID Switch — DEPRESS then RELEASE at intervals to effect immediate identification of aircraft on ground controller's display.

## **SECTION 4**

### **NORMAL PROCEDURES**

BEFORE TAKEOFF:

- (1) Function Switch — SBY.

TO TRANSMIT MODE A (AIRCRAFT IDENTIFICATION) CODES IN FLIGHT:

- (1) Reply-Code Selector Switches -- SELECT assigned code.

- (2) Function Switch — ON.
- (3) DIM Control — ADJUST light brilliance of reply lamp.

NOTE

During normal operation with function switch in ON position, reply lamp flashes indicating transponder replies to interrogationso

- (4) ID Button — DEPRESS momentarily when instructed by ground controller to "squawk IDENT" (reply lamp will glow steadily, indicating IDENT operation).

TO TRANSMIT MODE C (ALTITUDE REPORTING) CODES IN FLIGHT:

- (1) Reply-Code Selector Switches — SELECT assigned code.
- (2) Function Switch -- ALT.

NOTE

When directed by ground controller to "stop altitude squawk", turn Function Switch to ON for Mode A operation only.

NOTE

Pressure altitude is transmitted by the transponder for altitude squawk and conversion to indicated altitude is done in ATC computers. Altitude squawked will only agree with indicated altitude when the local altimeter setting in use by the ground controller is set in the aircraft altimeter.

- (3) DIM Control - ADJUST light brilliance of reply lamp.

TO SELF-TEST TRANSPONDER OPERATION:

- (1) Function Switch — SBY and wait 30 seconds for equipment to warm-up.
- (2) Function Switch — ON.
- (3) TST Button - DEPRESS (reply lamp should light brightly regardless of DIM control setting).
- (4) TST Button -- RELEASE for normal operation.

## **SECTION 5**

### **PERFORMANCE**

There is no change to the airplane performance when this avionic equipment is installed. However, the installation of an externally mounted antenna or several related external antennas, will result in a minor reduction in cruise performance.

# SUPPLEMENT

## CESSNA 400 MARKER BEACON

### (Type R-402A)

#### SECTION 1

#### GENERAL

The system consists of a 75 MHz marker beacon receiver, three indicator lights, one speaker/phone switch, a light dimming control, an ON/OFF/VOLUME control, and a 75 MHz marker beacon antenna. In addition, on 150, 182, 206, 207, 210 and 337 series models, a HI-LO sensitivity selector switch and a press-to-test button are provided. On all 172, 177, 177RG, 180 and 185 series models, a single, three position switch is provided for HI-LO sensitivity selection or test selection.

This system provides visual and aural indications of 75 MHz ILS marker beacon signals as the marker is passed. The following table lists the three most currently used marker facilities and their characteristics.

#### MARKER FACILITIES

MARKER	IDENTIFYING TONE	LIGHT*
Inner	Continuous 6 dots/sec (3000 Hz)	White
Middle	Alternate dots and dashes (1300 Hz)	Amber
Outer	2 dashes/sec (400 Hz)	Blue

\* When the identifying tone is keyed, the respective indicating light will blink accordingly.

Operating controls and indicator lights are shown and described in Figure 1.

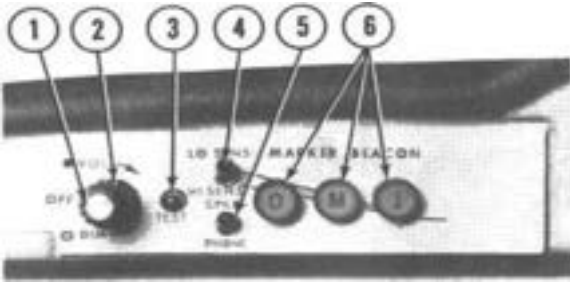

TYPICAL INSTALLATION  
ON ALL 150 MODEL SERIES

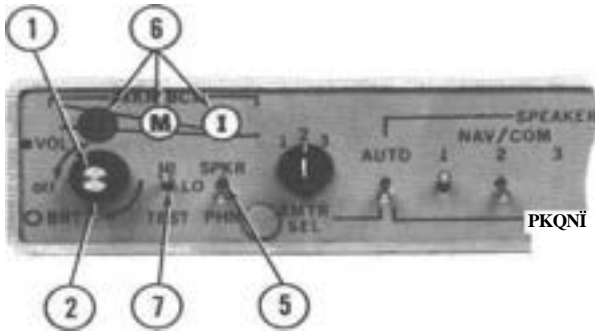

TYPICAL INSTALLATION  
ON ALL 172, 177, 177RG,  
180 & 185 MODEL SERIES

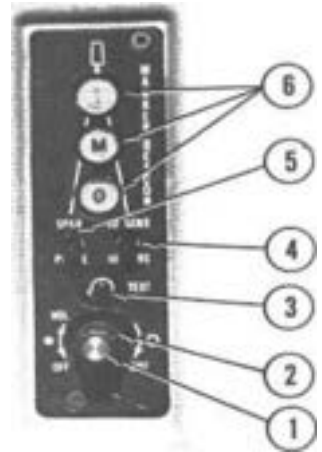

TYPICAL INSTALLATION  
ON ALL 182, 206, 207  
& 210 MODEL SERIES

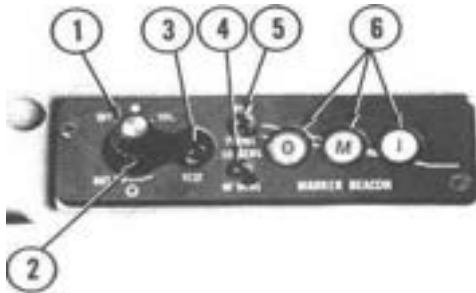

TYPICAL INSTALLATION  
ON ALL 337 MODEL SERIES

Figure 1. Cessna 400 Marker Beacon Operating Controls and Indicator Lights (Sheet 1 of 2)



1. OFF/VOLUME CONTROL - The small, inner control turns the set on or off and adjusts the audio listening level. Clockwise rotation turns the set on and increases the audio level.
2. DIM/BRT CONTROL - The large, outer control provides light dimming for the marker lights. Clockwise rotation increases light intensity.
3. TEST SWITCH - (150, 182, 206, 207, 210 & 337 Model Series Only) When the press-to-test switch button is depressed, the marker beacon lights will illuminate, indicating the lights are operational (the test position is a lamp test function only).

NOTE

Turn the set on, and rotate the DIM control clockwise (fully on) in order to view the marker beacon lights during test.

4. LO/HI SENS SWITCH - (150, 182, 206, 207, 210 & 337 Model Series Only) In the LO position (Up), receiver sensitivity is positioned for ILS approaches. In the HI position (Down), receiver sensitivity is positioned for airway flying.
5. SPEAKER/PHONE SWITCH - Selects speaker or phone for aural reception.
6. MARKER BEACON INDICATOR LIGHTS - Indicates passage of outer, middle and inner marker beacons. The OUTER light is blue, the MIDDLE light is amber and the INNER light is white.
7. HI/LO/TEST SWITCH - (172, 177, 177RG, 180 & 185 Model Series Only) In the HE position (Up), receiver sensitivity is positioned for airway flying. In the LO position (Center), receiver sensitivity is positioned for ILS approaches. In the TEST position (Down), the marker lights will illuminate, indicating the lights are operational (the test position is a lamp test function only).

NOTE

Turn the set on, and rotate the BRIGHT control clockwise (fully on) in order to view the marker beacon lights during test. The TEST position on the switch is spring loaded to return the switch to the LO SENS position when TEST position is released.

Figure 1. Cessna 400 Marker Beacon Operating Controls and Indicator Lights (Sheet 2 of 2)

## **SECTION 2**

### **LIMITATIONS**

There is no change to the airplane limitations when this avionics equipment is installed.

## **SECTION 3**

### **EMERGENCY PROCEDURES**

There is no change to the airplane emergency procedures when this avionics equipment is installed.

## **SECTION 4**

### **NORMAL PROCEDURES**

TO OPERATE:

- (1) OFF/VOL Control — VOL position and adjust to desired listening level.
- (2) LO/HI SENS Switch — SELECT HI position for airway flying or LO position for ILS approaches.
- (3) SPKR/PHONE Switch — SELECT speaker or phone audio.
- (4) TEST Switch — PRESS and ensure that marker beacon indicator lights are operative.

#### **NOTE**

Ensure that BRT control is on enough to view the marker beacon during this test.

## **SECTION 5**

### **PERFORMANCE**

There is no change to the airplane performance when this avionics equipment is installed. However, the installation of an externally mounted antenna or several related external antennas, will result in a minor reduction in cruise performance.

## **SUPPLEMENT**

### **CESSNA 400 GLIDE SLOPE**

**(Type R-443B)**

#### **SECTION 1**

#### **GENERAL**

The Cessna 400 Glide Slope is an airborne navigation receiver which receives and interprets glide slope signals from a ground-based Instrument Landing System (ILS). It is used with the localizer function of a VHF navigation system when making instrument approaches to an airport. The glide slope provides vertical path guidance while the localizer provides horizontal track guidance.

The Cessna 400 Glide Slope system consists of a remote-mounted receiver coupled to an existing navigation system, a panel-mounted indicator and an externally-mounted antenna. The glide slope receiver is designed to receive ILS glide slope signals on any of 40 channels. The channels are spaced 150 kHz apart and cover a frequency range of 329.15 MHz through 335.0 MHz. When a localizer frequency is selected on the NAV receiver, the associated glide slope frequency is selected automatically.

Operation of the Cessna 400 Glide Slope system is controlled by the associated navigation system. The functions and indications of a typical 300 series glide slope indicator are pictured and described in Figure 1. For functions and indications of the optional 400 series indicator or HSI indicator, refer to the 400 NAV/COM (Type RT-428A) or HSI (Type IG-832A) write-ups if they are listed in this section as options.

#### **SECTION 2**

#### **LIMITATIONS**

There is no change to the airplane limitations when this avionic equipment is installed. However, the pilot should be aware that on many Cessna airplanes equipped with the windshield-mounted glide slope antenna, pilots should avoid use of  $2700 \pm 100$  RPM with a two-bladed propeller (or  $1800 \pm 100$  RPM with a three-bladed propeller) during ILS approaches to avoid oscillations of the glide slope deviation pointer caused by propeller interference.



1. **GLIDE SLOPE DEVIATION POINTER** - Indicates deviation from normal glide slope.
2. **GLIDE SLOPE "OFF" FLAG** - When visible, indicates unreliable glide slope signal or improperly operating equipment. The flag disappears when a reliable glide slope signal is being received.

### **caution**

Spurious glide slope signals may exist in the area of the localizer back course approach which can cause the glide slope "OFF" flag to disappear and present unreliable glide slope information. Disregard all glide slope signal indications when making a localizer back course approach unless a glide slope (ILS BC) is specified on the approach and landing chart.

Figure 1. Typical 300 Series VOR/LOC/ILS Indicator

## **SECTION 3**

### **EMERGENCY PROCEDURES**

There is no change to the airplane emergency procedures when this avionic equipment is installed.

## **SECTION 4**

### **NORMAL PROCEDURES**

TO RECEIVE GLIDE SLOPE SIGNALS:

- (1) NAV Frequency Select Knobs — SELECT desired localizer frequency (glide slope frequency is automatically selected).
- (2) NAV/COM ID-T Switch -- SELECT ID position to disconnect filter from audio circuit.
- (3) NAV VOL Control -- ADJUST to desired listening level to confirm proper localizer station.

When glide slope "OFF" flag is visible, glide slope indications are unusable.

## **SECTION 5**

### **PERFORMANCE**

There is no change to the airplane performance when this avionic equipment is installed.







"TAKE YOUR CESSNA HOME  
FOR SERVICE AT THE SIGN  
OF THE CESSNA SHIELD"



**CESSNA AIRCRAFT COMPANY**

WICHITA, KANSAS

